

Mandan South Side Reservoir Coating

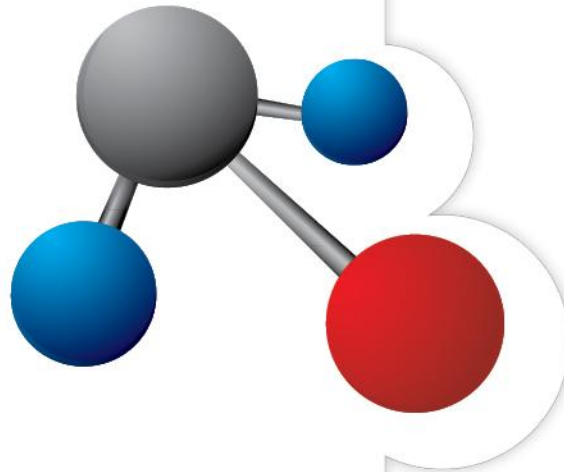

PREPARED FOR:



Mandan, North Dakota

*City of Mandan Project No. 1062
AE2S Project No. P00510-2026-002*

April 2026

PROJECT MANUAL

Advanced Engineering and Environmental Services, LLC
1815 Schafer St Ste 301,
Bismarck, North Dakota 58501
Ph: 701-221-0530 Web: www.AE2S.com



This page intentionally left blank

DIVISION 00 PROCUREMENT AND CONTRACTING REQUIREMENTS

SECTION 00 01 05 - CERTIFICATIONS PAGE

**PLANS AND SPECIFICATIONS FOR MANDAN SOUTH SIDE RESERVOIR
COATING
CITY OF MANDAN, NORTH DAKOTA
MANDAN NORTH DAKOTA**

APRIL 2026



ENGINEER

I hereby certify that these plans and specifications were prepared by me or under my direct supervision and that I am a duly Registered Professional Engineer under the laws of the State of North Dakota.

END OF SECTION

This page intentionally left blank

SECTION 00 01 10
TABLE OF CONTENTS

DIVISION 00 – PROCUREMENT AND CONTRACT REQUIREMENTS

00 01 01	PROJECT TITLE PAGE
00 01 05	PROFESSIONAL CERTIFICATION
00 01 10	TABLE OF CONTENTS
C-111	ADVERTISEMENT FOR BIDS FOR CONSTRUCTION CONTRACT
C-200	INSTRUCTIONS TO BIDDERS FOR CONSTRUCTION CONTRACT
C-410	BID FORM FOR CONSTRUCTION CONTRACT
C-451	QUALIFICATIONS STATEMENT
C-510	NOTICE OF AWARD
C-520	AGREEMENT BETWEEN OWNER AND CONTRACTOR FOR CONSTRUCTION CONTRACT (STIPULATED PRICE)
C-550	NOTICE TO PROCEED
C-610	PERFORMANCE BOND
C-615	PAYMENT BOND
C-620	CONTRACTORS APPLICATION FOR PAYMENT
C-625	CERTIFICATE OF SUBSTANTIAL COMPLETION
C-700	STANDARD GENERAL CONDITIONS (2018)
C-800	SUPPLEMENTARY CONDITIONS
C-940	WORK CHANGE DIRECTIVE
C-941	CHANGE ORDER
C-942	FIELD ORDER

DIVISION 01 – GENERAL REQUIREMENTS

01 11 13	WORK COVERED BY CONTRACT DOCUMENTS
01 26 00	CONTRACT MODIFICATION PROCEDURES
01 29 00	PAYMENT PROCEDURES
01 33 00	SUBMITTAL PROCEDURES
01 52 00	CONSTRUCTION FACILITIES AND SPECIAL PROVISIONS
01 77 00	CLOSEOUT PROCEDURES

DIVISION 09 - FINISHES

09 90 01	RESERVOIR AND APPURTENANCES PAINTING AND COATING
----------	--

END OF SECTION

This page intentionally left blank

ADVERTISEMENT FOR BIDS
City of Mandan
Mandan, ND
Mandan South Side Reservoir Coating

General Notice

City of Mandan (Owner) is requesting Bids for the construction of the following Project:

Mandan South Side Reservoir Coating
City of Mandan Project No. 1062
AE2S Project No. P00510-2026-002

Bids for the construction of the Project will be received at the Office of the City Administrator located at Mandan City Hall, 205 2nd Ave NW, Mandan, ND 58554 until **Thursday, May 28, 2026 at 10:00 AM** local time. At that time the Bids received will be publicly opened and read.

The Project includes the following Work:

Surface preparation and coating of the 4MG South Side Reservoir exterior walls and dome.

Bids are requested for the following Contract: **Mandan South Side Reservoir Coating**

Obtaining the Bidding Documents

Information and Bidding Documents for the Project can be found at the following designated website:

www.Ae2S.com

www.Questcdn.com Project #10159967

Bidding Documents may be downloaded from the designated website. Prospective Bidders are urged to register with the designated website as a plan holder, even if Bidding Documents are obtained from a plan room or source other than the designated website in either electronic or paper format. The designated website will be updated periodically with addenda, lists of registered plan holders, reports, and other information relevant to submitting a Bid for the Project. All official notifications, addenda, and other Bidding Documents will be offered only through the designated website. Neither Owner nor Engineer will be responsible for Bidding Documents, including addenda, if any, obtained from sources other than the designated website.

The Issuing Office for the Bidding Documents is:

Advanced Engineering and Environmental Services, LLC (AE2S)
1815 Schafer St., Suite 301, Bismarck, ND 58501

Prospective Bidders may obtain or examine the Bidding Documents at the Issuing Office on Monday through Friday between the hours of 8:00 AM to 5:00 PM, and may obtain copies of the Bidding Documents from the Issuing Office as described below. Partial sets of Bidding Documents will not be available from the Issuing Office. Neither Owner nor Engineer will be responsible for full or partial sets of Bidding Documents, including addenda, if any, obtained from sources other than the Issuing Office.

Copies of the Bidding Documents may be obtained from the Issuing Office or designated websites by paying a non-refundable deposit of \$25.00 for each set.

Instructions to Bidders.

Each bid must be accompanied by a separate envelope containing the contractor's license and bid security. The bid security must be in a sum equal to five percent (5%) of the full amount of the bid and must be in the form of a bidder's bond. A bidder's bond must be executed by the bidder as principal and by surety, conditioned that if the principal's bid is accepted and the contract awarded to the principal, the principal, within ten (10) days after notice of the award, shall execute a contract in accordance with the terms of the bid and the bid bond and any condition of the governing body. A countersignature of the bid bond is not required under this section. If a successful bidder does not execute a contract within the ten (10) days allowed, the bidder's bond must be forfeited to the governing body and the project awarded to the next lowest responsible bidder.

Bidder must be licensed for the full amount of the bid as required by 43-07-12 of the North Dakota Century Code.

Bids that do not fully comply with the requirements of 48-01.2, North Dakota Century Code, as amended and executed, are considered deficient and will be resealed and returned to the bidder immediately.

The Owner reserves the right to reject any and all bids and rebid the project until a satisfactory bid is received.

For all further requirements regarding bid submittal, qualifications, procedures, and contract award, refer to the Instructions to Bidders that are included in the Bidding Documents.

This Advertisement is issued by:

Owner: **City of Mandan**

By: **Jim Neubauer**

Title: **City Administrator**

Date: **[5/1/26, 5/9/26, 5/16/26]**

INSTRUCTIONS TO BIDDERS FOR CONSTRUCTION CONTRACT

TABLE OF CONTENTS

	Page
Article 1— Defined Terms.....	1
Article 2— Bidding Documents.....	1
Article 3— Qualifications of Bidders.....	2
Article 4— Pre-Bid Conference.....	3
Article 5— Site and Other Areas; Existing Site Conditions; Examination of Site; Owner’s Safety Program; Other Work at the Site.....	3
Article 6— Bidder’s Representations and Certifications.....	5
Article 7— Interpretations and Addenda.....	5
Article 8— Bid Security.....	5
Article 9— Contract Times.....	6
Article 10— Substitute and “Or Equal” Items.....	6
Article 11— Subcontractors, Suppliers, and Others.....	6
Article 12— Preparation of Bid.....	7
Article 13— Basis of Bid.....	8
Article 14— Submittal of Bid.....	9
Article 15— Modification and Withdrawal of Bid.....	10
Article 16— Opening of Bids.....	10
Article 17— Bids to Remain Subject to Acceptance.....	10
Article 18— Evaluation of Bids and Award of Contract.....	10
Article 19— Bonds and Insurance.....	11
Article 20— Signing of Agreement.....	11
Article 21— Sales and Use Taxes.....	11

ARTICLE 1—DEFINED TERMS

- 1.01 Terms used in these Instructions to Bidders have the meanings indicated in the General Conditions and Supplementary Conditions. Additional terms used in these Instructions to Bidders have the meanings indicated below:
- A. *Bidder* – The individual or entity who submits a Bid directly to Owner.
 - B. *Issuing Office*—The office from which the Bidding Documents are to be issued, and which registers plan holders.
 - C. *Owner* – The City of Mandan, North Dakota.
 - D. *Responsible Bid* – A responsible Bid is one from a Bidder that has the following:
 - 1. Financial resources, technical qualifications, experience, and facilities adequate to carry out the Project, or demonstrated ability to obtain these.
 - 2. Resources to meet the completion schedule contained in the Agreement.
 - 3. A satisfactory performance record for completion schedule of other projects.
 - E. *Responsive Bidder* – A responsive Bid is one from a Bidder that meets all of the requirements found in the Bidding Documents for submission of a Bid in accordance with Article 15 of this section and the General Requirements.
 - F. *Successful Bidder* – The lowest responsible Bidder submitting a responsive Bid to whom Owner (on the basis of Owner’s evaluation as provided herein) makes an award.

ARTICLE 2—BIDDING DOCUMENTS

- 2.01 Bidder shall obtain a complete set of Bidding Requirements and proposed Contract Documents (together, the Bidding Documents). See the Agreement for a list of the Contract Documents. It is Bidder’s responsibility to determine that it is using a complete set of documents in the preparation of a Bid. Bidder assumes sole responsibility for errors or misinterpretations resulting from the use of incomplete documents, by Bidder itself or by its prospective Subcontractors and Suppliers.
- 2.02 Bidding Documents are made available for the sole purpose of obtaining Bids for completion of the Project and permission to download or distribution of the Bidding Documents does not confer a license or grant permission or authorization for any other use. Authorization to download documents, or other distribution, includes the right for plan holders to print documents solely for their use, and the use of their prospective Subcontractors and Suppliers, provided the plan holder pays all costs associated with printing or reproduction. Printed documents may not be re-sold under any circumstances.
- 2.03 Owner has established a Bidding Documents Website as indicated in the Advertisement or invitation to bid. Owner recommends that Bidder register as a plan holder with the Issuing Office at such website, and obtain a complete set of the Bidding Documents from such website. Bidders may rely that sets of Bidding Documents obtained from the Bidding Documents Website are complete, unless an omission is blatant. Registered plan holders will receive Addenda issued by Owner.
- 2.04 Bidder may register as a plan holder and obtain complete sets of Bidding Documents, in the number and format stated in the Advertisement or invitation to bid, from the Issuing Office.

Bidders may rely that sets of Bidding Documents obtained from the Issuing Office are complete, unless an omission is blatant. Registered plan holders will receive Addenda issued by Owner.

2.05 Plan rooms (including construction information subscription services, and electronic and virtual plan rooms) may distribute the Bidding Documents, or make them available for examination. Those prospective bidders that obtain an electronic (digital) copy of the Bidding Documents from a plan room are encouraged to register as plan holders from the Bidding Documents Website or Issuing Office. Owner is not responsible for omissions in Bidding Documents or other documents obtained from plan rooms, or for a Bidder's failure to obtain Addenda from a plan room.

2.06 *Electronic Documents*

A. When the Bidding Requirements indicate that electronic (digital) copies of the Bidding Documents are available, such documents will be made available to the Bidders as Electronic Documents in the manner specified.

1. Bidding Documents will be provided in Adobe PDF (Portable Document Format) (.pdf) that is readable by the current Adobe Acrobat Reader Version . It is the intent of the Engineer and Owner that such Electronic Documents are to be exactly representative of the paper copies of the documents. However, because the Owner and Engineer cannot totally control the transmission and receipt of Electronic Documents nor the Contractor's means of reproduction of such documents, the Owner and Engineer cannot and do not guarantee that Electronic Documents and reproductions prepared from those versions are identical in every manner to the paper copies.

B. Unless otherwise stated in the Bidding Documents, the Bidder may use and rely upon complete sets of Electronic Documents of the Bidding Documents, described in Paragraph 2.06.A above. However, Bidder assumes all risks associated with differences arising from transmission/receipt of Electronic Documents versions of Bidding Documents and reproductions prepared from those versions and, further, assumes all risks, costs, and responsibility associated with use of the Electronic Documents versions to derive information that is not explicitly contained in printed paper versions of the documents, and for Bidder's reliance upon such derived information.

ARTICLE 3—QUALIFICATIONS OF BIDDERS

3.01 Bidder is to submit the following information with its Bid to demonstrate Bidder's qualifications to perform the Work:

A. Written evidence that the Bidder is regularly engaged in the business of construction similar size and scope projects involving municipal water supply projects.

B. Written evidence that the Bidder can maintain qualified technical staff and construction personnel necessary to complete the Work specified.

C. Written evidence establishing its qualifications such as, previous experience, and present commitments.

D. A written statement that Bidder is authorized to do business in the state where the Project is located, or a written certification that Bidder will obtain such authority prior to the Effective Date of the Contract.

E. Bidder's state or other contractor license number, if applicable.

- F. Subcontractor and Supplier qualification information.
 - G. Other required information regarding qualifications.
- 3.02 The Owner reserves the right to reject any Bid, if the experience qualifications submitted by, or investigation of, such Bidder fails to satisfy the Owner that such Bidder is properly qualified to carry of the obligation of the agreement and to complete the specified Work.
- 3.03 The Owner reserves the right to disqualify a superintendent based on past work history.
- 3.04 The Owner reserves the right to disqualify a Bidder based on work history or any other factor impacting the Bidder's status as a Responsible Bidder.
- 3.05 A Bidder's failure to submit required qualification information within the times indicated may disqualify Bidder from receiving an award of the Contract.
- 3.06 No requirement in this Article 3 to submit information will prejudice the right of Owner to seek additional pertinent information regarding Bidder's qualifications.

ARTICLE 4—PRE-BID CONFERENCE

- 4.01 A pre-bid conference will not be conducted for this Project.

ARTICLE 5—SITE AND OTHER AREAS; EXISTING SITE CONDITIONS; EXAMINATION OF SITE; OWNER'S SAFETY PROGRAM; OTHER WORK AT THE SITE

5.01 *Site and Other Areas*

- A. The Site is identified in the Bidding Documents. By definition, the Site includes rights-of-way, easements, and other lands furnished by Owner for the use of the Contractor. Any additional lands required for temporary construction facilities, construction equipment, or storage of materials and equipment, and any access needed for such additional lands, are to be obtained and paid for by Contractor.

5.02 *Existing Site Conditions*

A. *Subsurface and Physical Conditions; Hazardous Environmental Conditions*

1. The Supplementary Conditions identify the following regarding existing conditions at or adjacent to the Site:
 - a. Those reports of explorations and tests of subsurface conditions at or adjacent to the Site that contain Technical Data.
 - b. Those drawings known to Owner of existing physical conditions at or adjacent to the Site, including those drawings depicting existing surface or subsurface structures at or adjacent to the Site (except Underground Facilities), that contain Technical Data.
 - c. Reports and drawings known to Owner relating to Hazardous Environmental Conditions that have been identified at or adjacent to the Site.
 - d. Technical Data contained in such reports and drawings.
2. Owner will make copies of reports and drawings referenced above available to any Bidder on request. These reports and drawings are not part of the Contract Documents,

but the Technical Data contained therein upon whose accuracy Bidder is entitled to rely, as provided in the General Conditions, has been identified and established in the Supplementary Conditions. Bidder is responsible for any interpretation or conclusion Bidder draws from any Technical Data or any other data, interpretations, opinions, or information contained in such reports or shown or indicated in such drawings.

3. If the Supplementary Conditions do not identify Technical Data, the default definition of Technical Data set forth in Article 1 of the General Conditions will apply.

B. *Underground Facilities:* Underground Facilities are shown or indicated on the Drawings, pursuant to Paragraph 5.05 of the General Conditions, and not in the drawings referred to in Paragraph 5.02.A of these Instructions to Bidders. Information and data regarding the presence or location of Underground Facilities are not intended to be categorized, identified, or defined as Technical Data.

5.03 *Other Site-related Documents*

A. Site-related documents are provided as part of Attachment No. 1 of the bidding documents.

5.04 *Site Visit and Testing by Bidders*

A. Bidder may visit the Site and conduct a thorough visual examination of the Site and adjacent areas. During the visit the Bidder must not disturb any ongoing operations at the Site.

B. Bidders visiting the Site are required to arrange their own transportation to the Site.

C. All access to the Site other than during a regularly scheduled Site visit must be coordinated through the Owner or Engineer. Bidder must conduct the Site visit during normal working hours.

D. Bidder is not required to conduct any subsurface testing, or exhaustive investigations of Site conditions.

E. On request, and to the extent Owner has control over the Site, and schedule permitting, the Owner will provide Bidder general access to the Site to conduct such additional examinations, investigations, explorations, tests, and studies as Bidder deems necessary for preparing and submitting a successful Bid. Owner will not have any obligation to grant such access if doing so is not practical because of existing operations, security or safety concerns, or restraints on Owner's authority regarding the Site. Bidder is responsible for establishing access needed to reach specific selected test sites.

F. Bidder must comply with all applicable Laws and Regulations regarding excavation and location of utilities, obtain all permits, and comply with all terms and conditions established by Owner or by property owners or other entities controlling the Site with respect to schedule, access, existing operations, security, liability insurance, and applicable safety programs.

G. Bidder must fill all holes and clean up and restore the Site to its former condition upon completion of such explorations, investigations, tests, and studies.

5.05 *Owner's Safety Program*

A. Site visits and work at the Site may be governed by an Owner safety program. If an Owner safety program exists, it will be noted in the Supplementary Conditions.

5.06 *Other Work at the Site*

- A. Reference is made to Article 8 of the Supplementary Conditions for the identification of the general nature of other work of which Owner is aware (if any) that is to be performed at the Site by Owner or others (such as utilities and other prime contractors) and relates to the Work contemplated by these Bidding Documents. If Owner is party to a written contract for such other work, then on request, Owner will provide to each Bidder access to examine such contracts (other than portions thereof related to price and other confidential matters), if any.

ARTICLE 6—BIDDER’S REPRESENTATIONS AND CERTIFICATIONS

6.01 *Express Representations and Certifications in Bid Form, Agreement*

- A. The Bid Form that each Bidder will submit contains express representations regarding the Bidder’s examination of Project documentation, Site visit, and preparation of the Bid, and certifications regarding lack of collusion or fraud in connection with the Bid. Bidder should review these representations and certifications, and assure that Bidder can make the representations and certifications in good faith, before executing and submitting its Bid.
- B. If Bidder is awarded the Contract, Bidder (as Contractor) will make similar express representations and certifications when it executes the Agreement.

ARTICLE 7—INTERPRETATIONS AND ADDENDA

- 7.01 Owner on its own initiative may issue Addenda to clarify, correct, supplement, or change the Bidding Documents.
- 7.02 Bidder shall submit all questions about the meaning or intent of the Bidding Documents to Engineer in writing. Contact information and submittal procedures for such questions are as follows:
 - A. Submit questions to Tyler Fode, PE at Tyler.Fode@AE2S.com
- 7.03 Interpretations or clarifications considered necessary by Engineer in response to such questions will be issued by Addenda delivered to all registered plan holders. Questions received less than seven days prior to the date for opening of Bids may not be answered.
- 7.04 Only responses set forth in an Addendum will be binding. Oral and other interpretations or clarifications will be without legal effect. Responses to questions are not part of the Contract Documents unless set forth in an Addendum that expressly modifies or supplements the Contract Documents.

ARTICLE 8—BID SECURITY

- 8.01 A Bid must be accompanied by Bid security **in a separate envelope** made payable to Owner in an amount of 5 (five) percent of Bidder’s maximum Bid price (determined by adding the base bid and all alternates) and in the form of a Bid bond issued by a surety meeting the requirements of Paragraph 6.01 of the General Conditions. Such Bid bond will be issued in the form included in the Bidding Documents.
- 8.02 The Bid security of the apparent Successful Bidder will be retained until Owner awards the contract to such Bidder, and such Bidder has executed the Contract, furnished the required Contract security, and met the other conditions of the Notice of Award, whereupon the Bid

security will be released. If the Successful Bidder fails to execute and deliver the Contract and furnish the required Contract security within 15 days after the Notice of Award, Owner may consider Bidder to be in default, annul the Notice of Award, and the Bid security of that Bidder will be forfeited, in whole in the case of a penal sum bid bond, and to the extent of Owner's damages in the case of a damages-form bond. Such forfeiture will be Owner's exclusive remedy if Bidder defaults.

- 8.03 The Bid security of other Bidders that Owner believes to have a reasonable chance of receiving the award may be retained by Owner until the earlier of 7 days after the Effective Date of the Contract or 61 days after the Bid opening, whereupon Bid security furnished by such Bidders will be released.
- 8.04 Bid security of other Bidders that Owner believes do not have a reasonable chance of receiving the award will be released within 7 days after the Bid opening.

ARTICLE 9—CONTRACT TIMES

- 9.01 The number of days within which, or the dates by which, the Work is to be (a) substantially completed and (b) ready for final payment, and (c) Milestones (if any) are to be achieved, are set forth in the Agreement.
- 9.02 Provisions for liquidated damages, if any, for failure to timely attain a Milestone, Substantial Completion, or completion of the Work in readiness for final payment, are set forth in the Agreement.

ARTICLE 10—SUBSTITUTE AND "OR EQUAL" ITEMS

- 10.01 The Contract for the Work, as awarded, will be on the basis of materials and equipment specified or described in the Bidding Documents, and those "or-equal" or substitute or materials and equipment subsequently approved by Engineer prior to the submittal of Bids and identified by Addendum. No item of material or equipment will be considered by Engineer as an "or-equal" or substitute unless written request for approval has been submitted by Bidder and has been received by Engineer within 10 days of the issuance of the Advertisement for Bids or invitation to Bidders. Each such request must comply with the requirements of Paragraphs 7.05 and 7.06 of the General Conditions, and the review of the request will be governed by the principles in those paragraphs. The burden of proof of the merit of the proposed item is upon Bidder. Engineer's decision of approval or disapproval of a proposed item will be final. If Engineer approves any such proposed item, such approval will be set forth in an Addendum issued to all registered Bidders. Bidders cannot rely upon approvals made in any other manner.
- 10.02 All prices that Bidder sets forth in its Bid will be based on the presumption that the Contractor will furnish the materials and equipment specified or described in the Bidding Documents, as supplemented by Addenda. Any assumptions regarding the possibility of post-Bid approvals of "or-equal" or substitution requests are made at Bidder's sole risk.

ARTICLE 11—SUBCONTRACTORS, SUPPLIERS, AND OTHERS

- 11.01 A Bidder must be prepared to retain specific Subcontractors and Suppliers for the performance of the Work if required to do so by the Bidding Documents or in the Specifications. If a prospective

Bidder objects to retaining any such Subcontractor or Supplier and the concern is not relieved by an Addendum, then the prospective Bidder should refrain from submitting a Bid.

- 11.02 The apparent Successful Bidder, and any other Bidder so requested, must submit to Owner a list of the Subcontractors or Suppliers proposed for the Work within five days after Bid opening.
- 11.03 If requested by Owner, such list must be accompanied by an experience statement with pertinent information regarding similar projects and other evidence of qualification for each such Subcontractor or Supplier. If Owner or Engineer, after due investigation, has reasonable objection to any proposed Subcontractor or Supplier, Owner may, before the Notice of Award is given, request apparent Successful Bidder to submit an acceptable substitute, in which case apparent Successful Bidder will submit a substitute, Bidder's Bid price will be increased (or decreased) by the difference in cost occasioned by such substitution, and Owner may consider such price adjustment in evaluating Bids and making the Contract award.
- 11.04 If apparent Successful Bidder declines to make any such substitution, Owner may award the Contract to the next lowest Bidder that proposes to use acceptable Subcontractors and Suppliers. Declining to make requested substitutions will constitute grounds for forfeiture of the Bid security of any Bidder. Any Subcontractor or Supplier, so listed and against which Owner or Engineer makes no written objection prior to the giving of the Notice of Award will be deemed acceptable to Owner and Engineer subject to subsequent revocation of such acceptance as provided in Paragraph 7.07 of the General Conditions.

ARTICLE 12—PREPARATION OF BID

- 12.01 The Bid Form is included with the Bidding Documents.
 - A. All blanks on the Bid Form must be completed in ink and the Bid Form signed in ink. Erasures or alterations must be initialed in ink by the person signing the Bid Form. A Bid price must be indicated for each section, Bid item, alternate, adjustment unit price item, and unit price item listed therein.
 - B. If the Bid Form expressly indicates that submitting pricing on a specific alternate item is optional, and Bidder elects to not furnish pricing for such optional alternate item, then Bidder may enter the words "No Bid" or "Not Applicable."
- 12.02 If Bidder has obtained the Bidding Documents as Electronic Documents, then Bidder shall prepare its Bid on a paper copy of the Bid Form printed from the Electronic Documents version of the Bidding Documents. The printed copy of the Bid Form must be clearly legible, printed on 8½ inch by 11-inch paper and as closely identical in appearance to the Electronic Document version of the Bid Form as may be practical. The Owner reserves the right to accept Bid Forms which nominally vary in appearance from the original paper version of the Bid Form, providing that all required information and submittals are included with the Bid.
- 12.03 A Bid by a corporation must be executed in the corporate name by a corporate officer (whose title must appear under the signature), accompanied by evidence of authority to sign. The corporate address and state of incorporation must be shown.
- 12.04 A Bid by a partnership must be executed in the partnership name and signed by a partner (whose title must appear under the signature), accompanied by evidence of authority to sign. The official address of the partnership must be shown.

- 12.05 A Bid by a limited liability company must be executed in the name of the firm by a member or other authorized person and accompanied by evidence of authority to sign. The state of formation of the firm and the official address of the firm must be shown.
- 12.06 A Bid by an individual must show the Bidder's name and official address.
- 12.07 A Bid by a joint venture must be executed by an authorized representative of each joint venturer in the manner indicated on the Bid Form. The joint venture must have been formally established prior to submittal of a Bid, and the official address of the joint venture must be shown.
- 12.08 All names must be printed in ink below the signatures.
- 12.09 The Bid must contain an acknowledgment of receipt of all Addenda, the numbers of which must be filled in on the Bid Form.
- 12.10 Postal and e-mail addresses and telephone number for communications regarding the Bid must be shown.
- 12.11 The Bid must contain evidence of Bidder's authority to do business in the state where the Project is located, or Bidder must certify in writing that it will obtain such authority within the time for acceptance of Bids and attach such certification to the Bid.
- 12.12 If Bidder is required to be licensed to submit a Bid or perform the Work in the state where the Project is located, the Bid must contain evidence of Bidder's licensure, or Bidder must certify in writing that it will obtain such licensure within the time for acceptance of Bids and attach such certification to the Bid. Bidder's state contractor license number, if any, must also be shown on the Bid Form.
- A. A copy of Contractor's License or Certificate of Renewal as issued by the Secretary of State to do business in the State of North Dakota must be enclosed in the same envelope as the bid bond as required under Section 43-07-12. All bids and proposals for the construction of any public contract project subject to the provisions of this chapter shall contain a statement showing that the Bidder or Contractor is duly and regularly licensed hereunder. The number and class of such license then held by such public contractor shall appear upon such bid or proposal. No contract shall be awarded to any contractor unless he is the holder of a license in the class within which the value of the project shall fall as hereinbefore provided. A contractor must be the holder of a license at least ten days prior to the date set for receiving bids to be a qualified bidder. The bid shall be submitted in a separate sealed envelope upon which there is disclosed the following information:
1. The class of license held by the Bidder.
 2. The number of the Bidder's license.
 3. The name of the person, firm, or corporation submitting the bid.
 4. Date on which license was issued or renewed.
 5. A bid submitted without this information shall not be considered.

ARTICLE 13—BASIS OF BID

13.01 *Lump Sum*

- A. Bidders must submit a Bid on a lump sum basis as set forth in the Bid Form.

ARTICLE 14—SUBMITTAL OF BID

- 14.01 The Bidding Documents include one separate unbound copy of the Bid Form, and, if required, the Bid Bond Form. The unbound copy of the Bid Form is to be completed and submitted with the Bid security and the other documents required to be submitted under the terms of Article 2 of the Bid Form.
- 14.02 A Bid must be received no later than the date and time prescribed and at the place indicated in the Advertisement or invitation to bid and must be enclosed in a plainly marked package with the Project title, and, if applicable, the designated portion of the Project for which the Bid is submitted, the name and address of Bidder, and must be accompanied by the Bid security and other required documents. If a Bid is sent by mail or other delivery system, the sealed envelope containing the Bid must be enclosed in a separate package plainly marked on the outside with the notation "BID ENCLOSED." A mailed Bid must be addressed to the location designated in the Advertisement.
- 14.03 Bids received after the date and time prescribed for the opening of bids, or not submitted at the correct location or in the designated manner, will not be accepted and will be returned to the Bidder unopened.
- 14.04 Bidder shall prepare the Bid as follows:
- A. Enclose in an opaque sealed envelope:
 - 1. Completed Bid Form;
 - 2. Completed Qualifications Statement;
 - B. Mark on outside of opaque sealed envelopes:
 - 1. "BID ENCLOSED"
 - 2. Attn: City Administrator
City of Mandan
205 2nd Avenue NW
Mandan, ND 58554
 - 3. BID FOR: Mandan South Side Reservoir Coating
 - 4. BID FROM: (Name and address of Bidder)
 - 5. Acknowledgement of Receipt of Addenda through .
 - a. **ANY BIDDER WHO FAILS TO ACKNOWLEDGE RECEIPT OF ADDENDA ON THE OUTSIDE OF THE BID ENVELOPE MAY BE CONSIDERED NON-RESPONSIVE AND THE BID MAY NOT BE OPENED.**
 - C. Attach to the outside of the sealed opaque envelope containing the Bid a separate opaque sealed envelope labeled "Bid Security." The following information shall be included within this separate sealed envelope:
 - 1. Bid security in the form of a Bond.
 - 2. North Dakota State Contractor's License or Certificate of Renewal.

- 3. ANY BIDDER WHO FAILS TO INCLUDE ALL FORMS INDICATED ABOVE WITHIN THE BID SECURITY ENVELOPE MAY BE CONSIDERED NON-RESPONSIVE AND THAT BID MAY NOT BE OPENED.**

ARTICLE 15—MODIFICATION AND WITHDRAWAL OF BID

- 15.01 An unopened Bid may be withdrawn by an appropriate document duly executed in the same manner that a Bid must be executed and delivered to the place where Bids are to be submitted prior to the date and time for the opening of Bids. Upon receipt of such notice, the unopened Bid will be returned to the Bidder.
- 15.02 If a Bidder wishes to modify its Bid prior to Bid opening, Bidder must withdraw its initial Bid in the manner specified in Paragraph 15.01 and submit a new Bid prior to the date and time for the opening of Bids.
- 15.03 If within 24 hours after Bids are opened any Bidder files a duly signed written notice with Owner and promptly thereafter demonstrates to the reasonable satisfaction of Owner that there was a material and substantial mistake in the preparation of its Bid, the Bidder may withdraw its Bid, and the Bid security will be returned. Thereafter, if the Work is rebid, the Bidder will be disqualified from further bidding on the Work.

ARTICLE 16—OPENING OF BIDS

- 16.01 Bids will be opened at the time and place indicated in the advertisement or invitation to bid and, unless obviously non-responsive, read aloud publicly. An abstract of the amounts of the base Bids and major alternates, if any, will be made available to Bidders after the opening of Bids.

ARTICLE 17—BIDS TO REMAIN SUBJECT TO ACCEPTANCE

- 17.01 All Bids will remain subject to acceptance for the period of time stated in the Bid Form, but Owner may, in its sole discretion, release any Bid and return the Bid security prior to the end of this period.

ARTICLE 18—EVALUATION OF BIDS AND AWARD OF CONTRACT

- 18.01 Owner reserves the right to reject any or all Bids, including without limitation, nonconforming, nonresponsive, unbalanced, or conditional Bids. Owner also reserves the right to waive all minor Bid informalities not involving price, time, or changes in the Work.
- 18.02 Owner will reject the Bid of any Bidder that Owner finds, after reasonable inquiry and evaluation, to not be responsible.
- 18.03 If Bidder purports to add terms or conditions to its Bid, takes exception to any provision of the Bidding Documents, or attempts to alter the contents of the Contract Documents for purposes of

the Bid, whether in the Bid itself or in a separate communication to Owner or Engineer, then Owner will reject the Bid as nonresponsive.

18.04 If Owner awards the contract for the Work, such award will be to the responsible Bidder submitting the lowest responsive Bid.

18.05 *Evaluation of Bids*

A. In evaluating Bids, Owner will consider whether the Bids comply with the prescribed requirements, and such alternates, unit prices, and other data, as may be requested in the Bid Form or prior to the Notice of Award.

B. In the comparison of Bids, alternates will be applied in the same order of priority as listed in the Bid Form. To determine the Bid prices for purposes of comparison, Owner will announce to all bidders a “Base Bid plus alternates” budget after receiving all Bids, but prior to opening them. For comparison purposes alternates will be accepted, following the order of priority established in the Bid Form, until doing so would cause the budget to be exceeded. After determination of the Successful Bidder based on this comparative process and on the responsiveness, responsibility, and other factors set forth in these Instructions, the award may be made to said Successful Bidder on its base Bid and any combination of its additive alternate Bids for which Owner determines funds will be available at the time of award.

18.06 Owner may conduct such investigations as Owner deems necessary to establish the responsibility, qualifications, and financial ability of Bidders and any proposed Subcontractors or Suppliers.

ARTICLE 19—BONDS AND INSURANCE

19.01 Article 6 of the General Conditions, as may be modified by the Supplementary Conditions, sets forth Owner’s requirements as to performance and payment bonds, other required bonds (if any), and insurance. When the Successful Bidder delivers the executed Agreement to Owner, it must be accompanied by required bonds and insurance documentation.

19.02 Article 8, Bid Security, of these Instructions, addresses any requirements for providing bid bonds as part of the bidding process.

ARTICLE 20—SIGNING OF AGREEMENT

20.01 When Owner issues a Notice of Award to the Successful Bidder, it will be accompanied by the unexecuted counterparts of the Agreement along with the other Contract Documents as identified in the Agreement. Within 15 days thereafter, Successful Bidder must execute and deliver the required number of counterparts of the Agreement and any bonds and insurance documentation required to be delivered by the Contract Documents to Owner. Within 10 days thereafter, Owner will deliver one fully executed counterpart of the Agreement to Successful Bidder, together with printed and electronic copies of the Contract Documents as stated in Paragraph 2.02 of the General Conditions.

ARTICLE 21—SALES AND USE TAXES

21.01 Owner is not exempt from state and local sales and use taxes on materials and equipment to be incorporated in the Work. Said taxes must be included in the Bid.

BID FORM FOR CONSTRUCTION CONTRACT

The terms used in this Bid with initial capital letters have the meanings stated in the Instructions to Bidders, the General Conditions, and the Supplementary Conditions.

ARTICLE 1—OWNER AND BIDDER

1.01 This Bid is submitted to:

City of Mandan
Attn: Jarek Wigness, City Engineer
205 2nd Avenue NW
Mandan, ND 58554

1.02 The undersigned Bidder proposes and agrees, if this Bid is accepted, to enter into an Agreement with Owner in the form included in the Bidding Documents to perform all Work as specified or indicated in the Bidding Documents for the prices and within the times indicated in this Bid and in accordance with the other terms and conditions of the Bidding Documents.

ARTICLE 2—ATTACHMENTS TO THIS BID

2.01 The following documents are submitted with and made a condition of this Bid:

- A. In one opaque and sealed envelope labeled as described in Article 14 of C-200
 - 1. Completed Bid Form
 - 2. Completed Qualification Statement
- B. In a second opaque and sealed envelope labeled in Article 14 of C-200:
 - 1. Required Bid security;
 - 2. North Dakota Contractor's license or Certificate of Renewal.
 - 3. Evidence of authority to do business in the state of the Project; or a written covenant to obtain such authority within the time for acceptance of Bids;

ARTICLE 3—BASIS OF BID—LUMP SUM BID AND UNIT PRICES

3.01 *Lump Sum Bids*

- A. Bidder will complete the Work in accordance with the Contract Documents for the following lump sum (stipulated) price(s), together with any Unit Prices indicated in Paragraph 3.02:
 - 1. Lump Sum Price (Single Lump Sum)

Lump Sum Bid Price	\$
--------------------	----

ARTICLE 4—

ARTICLE 4—TIME OF COMPLETION

- 4.01 Bidder agrees that the Work will be substantially complete and will be completed and ready for final payment in accordance with Paragraph 15.06 of the General Conditions on or before the dates or within the number of calendar days indicated in the Agreement.
- 4.02 Bidder accepts the provisions of the Agreement as to liquidated damages.

ARTICLE 5—BIDDER’S ACKNOWLEDGEMENTS: ACCEPTANCE PERIOD, INSTRUCTIONS, AND RECEIPT OF ADDENDA

- 5.01 *Bid Acceptance Period*
 - A. This Bid will remain subject to acceptance for 30 days after the Bid opening, or for such longer period of time that Bidder may agree to in writing upon request of Owner.
- 5.02 *Instructions to Bidders*
 - A. Bidder accepts all of the terms and conditions of the Instructions to Bidders, including without limitation those dealing with the disposition of Bid security.
- 5.03 *Receipt of Addenda*
 - A. Bidder hereby acknowledges receipt of the following Addenda:

Addendum Number	Addendum Date

ARTICLE 6—BIDDER’S REPRESENTATIONS AND CERTIFICATIONS

- 6.01 *Bidder’s Representations*
 - A. In submitting this Bid, Bidder represents the following:
 - 1. Bidder has examined and carefully studied the Bidding Documents, including Addenda.
 - 2. Bidder has visited the Site, conducted a thorough visual examination of the Site and adjacent areas, and become familiar with the general, local, and Site conditions that may affect cost, progress, and performance of the Work.
 - 3. Bidder is familiar with all Laws and Regulations that may affect cost, progress, and performance of the Work.
 - 4. Bidder has carefully studied the reports of explorations and tests of subsurface conditions at or adjacent to the Site and the drawings of physical conditions relating to existing surface or subsurface structures at the Site that have been identified in the Supplementary Conditions, with respect to the Technical Data in such reports and drawings.
 - 5. Bidder has carefully studied the reports and drawings relating to Hazardous Environmental Conditions, if any, at or adjacent to the Site that have been identified in the Supplementary Conditions, with respect to Technical Data in such reports and drawings.

6. Bidder has considered the information known to Bidder itself; information commonly known to contractors doing business in the locality of the Site; information and observations obtained from visits to the Site; the Bidding Documents; and the Technical Data identified in the Supplementary Conditions or by definition, with respect to the effect of such information, observations, and Technical Data on (a) the cost, progress, and performance of the Work; (b) the means, methods, techniques, sequences, and procedures of construction to be employed by Bidder, if selected as Contractor; and (c) Bidder's (Contractor's) safety precautions and programs.
7. Based on the information and observations referred to in the preceding paragraph, Bidder agrees that no further examinations, investigations, explorations, tests, studies, or data are necessary for the performance of the Work at the Contract Price, within the Contract Times, and in accordance with the other terms and conditions of the Contract.
8. Bidder is aware of the general nature of work to be performed by Owner and others at the Site that relates to the Work as indicated in the Bidding Documents.
9. Bidder has given Engineer written notice of all conflicts, errors, ambiguities, or discrepancies that Bidder has discovered in the Bidding Documents, and of discrepancies between Site conditions and the Contract Documents, and the written resolution thereof by Engineer is acceptable to Contractor.
10. The Bidding Documents are generally sufficient to indicate and convey understanding of all terms and conditions for performance and furnishing of the Work.
11. The submission of this Bid constitutes an incontrovertible representation by Bidder that without exception the Bid and all prices in the Bid are premised upon performing and furnishing the Work required by the Bidding Documents.

6.02 *Bidder's Certifications*

- A. The Bidder certifies the following:
 1. This Bid is genuine and not made in the interest of or on behalf of any undisclosed individual or entity and is not submitted in conformity with any collusive agreement or rules of any group, association, organization, or corporation.
 2. Bidder has not directly or indirectly induced or solicited any other Bidder to submit a false or sham Bid.
 3. Bidder has not solicited or induced any individual or entity to refrain from bidding.
 4. Bidder has not engaged in corrupt, fraudulent, collusive, or coercive practices in competing for the Contract. For the purposes of this Paragraph 8.02.A:
 - a. Corrupt practice means the offering, giving, receiving, or soliciting of anything of value likely to influence the action of a public official in the bidding process.
 - b. Fraudulent practice means an intentional misrepresentation of facts made (a) to influence the bidding process to the detriment of Owner, (b) to establish bid prices at artificial non-competitive levels, or (c) to deprive Owner of the benefits of free and open competition.

- c. Collusive practice means a scheme or arrangement between two or more Bidders, with or without the knowledge of Owner, a purpose of which is to establish bid prices at artificial, non-competitive levels.
- d. Coercive practice means harming or threatening to harm, directly or indirectly, persons or their property to influence their participation in the bidding process or affect the execution of the Contract.

BIDDER hereby submits this Bid as set forth above:

Bidder:

(typed or printed name of organization)

By: _____
(individual's signature)

Name: _____
(typed or printed)

Title: _____
(typed or printed)

Date: _____
(typed or printed)

If Bidder is a corporation, a partnership, or a joint venture, attach evidence of authority to sign.

Attest: _____
(individual's signature)

Name: _____
(typed or printed)

Title: _____
(typed or printed)

Date: _____
(typed or printed)

Address for giving notices:

Bidder's Contact:

Name: _____
(typed or printed)

Title: _____
(typed or printed)

Phone: _____

Email: _____

Address: _____

Bidder's Contractor License No.: (if applicable) _____

This page intentionally left blank

ARTICLE 1—GENERAL INFORMATION

1.01 Provide contact information for the Business:

Legal Name of Business:			
Corporate Office			
Name:		Phone number:	
Title:		Email address:	
Business address of corporate office:			
Local Office			
Name:		Phone number:	
Title:		Email address:	
Business address of local office:			

1.02 Provide information on the Business’s organizational structure:

Form of Business:	<input type="checkbox"/> Sole Proprietorship <input type="checkbox"/> Partnership <input type="checkbox"/> Corporation		
<input type="checkbox"/> Limited Liability Company <input type="checkbox"/> Joint Venture comprised of the following companies:			
1.			
2.			
3.			
Provide a separate Qualification Statement for each Joint Venturer.			
Date Business was formed:		State in which Business was formed:	
Is this Business authorized to operate in the Project location?		<input type="checkbox"/> Yes <input type="checkbox"/> No <input type="checkbox"/> Pending	

1.03 Identify all businesses that own Business in whole or in part (25% or greater), or that are wholly or partly (25% or greater) owned by Business:

Name of business:		Affiliation:	
Address:			
Name of business:		Affiliation:	
Address:			
Name of business:		Affiliation:	
Address:			

ARTICLE 2—NOT USED

2.01 Not used.

ARTICLE 3—NOT USED

3.01 Not used.

ARTICLE 4—SAFETY

4.01 Provide information regarding Business’s safety organization and safety performance.

Name of Business’s Safety Officer:			
Safety Certifications			
Certification Name	Issuing Agency		Expiration

4.02 Provide Worker’s Compensation Insurance Experience Modification Rate (EMR), Total Recordable Frequency Rate (TRFR) for incidents, and Total Number of Recorded Manhours (MH) for the last 3 years and the EMR, TRFR, and MH history for the last 3 years of any proposed Subcontractor(s) that will provide Work valued at 10% or more of the Contract Price. Provide documentation of the EMR history for Business and Subcontractor(s).

Year									
Company	EMR	TRFR	MH	EMR	TRFR	MH	EMR	TRFR	MH

ARTICLE 5—NOT USED

5.01 Not used.

ARTICLE 6—SURETY INFORMATION

6.01 Provide information regarding the surety company that will issue required bonds on behalf of the Business, including but not limited to performance and payment bonds.

Surety Name:			
Surety is a corporation organized and existing under the laws of the state of:			

Is surety authorized to provide surety bonds in the Project location?		<input type="checkbox"/> Yes <input type="checkbox"/> No	
Is surety listed in "Companies Holding Certificates of Authority as Acceptable Sureties on Federal Bonds and as Acceptable Reinsuring Companies" published in Department Circular 570 (as amended) by the Bureau of the Fiscal Service, U.S. Department of the Treasury? <input type="checkbox"/> Yes <input type="checkbox"/> No			
Mailing Address (principal place of business):			
Physical Address (principal place of business):			
Phone (main):		Phone (claims):	

ARTICLE 7—INSURANCE

7.01 Provide information regarding Business’s insurance company(s), including but not limited to its Commercial General Liability carrier. Provide information for each provider.

Name of insurance provider, and type of policy (CLE, auto, etc.):			
Insurance Provider		Type of Policy (Coverage Provided)	
Are providers licensed or authorized to issue policies in the Project location?		<input type="checkbox"/> Yes <input type="checkbox"/> No	
Does provider have an A.M. Best Rating of A-VII or better?		<input type="checkbox"/> Yes <input type="checkbox"/> No	
Mailing Address (principal place of business):			
Physical Address (principal place of business):			
Phone (main):		Phone (claims):	

ARTICLE 8—CONSTRUCTION EXPERIENCE

8.01 Provide information that will identify the overall size and capacity of the Business.

Average number of current full-time employees:	
Estimate of revenue for the current year:	
Estimate of revenue for the previous year:	

8.02 Provide information regarding the Business’s previous contracting experience.

Years of experience with projects like the proposed project:		
As a general contractor:		As a joint venturer:
Has Business, or a predecessor in interest, or an affiliate identified in Paragraph 1.03:		
Been disqualified as a bidder by any local, state, or federal agency within the last 5 years? <input type="checkbox"/> Yes <input type="checkbox"/> No		
Been barred from contracting by any local, state, or federal agency within the last 5 years? <input type="checkbox"/> Yes <input type="checkbox"/> No		
Been released from a bid in the past 5 years? <input type="checkbox"/> Yes <input type="checkbox"/> No		
Defaulted on a project or failed to complete any contract awarded to it? <input type="checkbox"/> Yes <input type="checkbox"/> No		
Refused to construct or refused to provide materials defined in the contract documents or in a change order? <input type="checkbox"/> Yes <input type="checkbox"/> No		
Been a party to any currently pending litigation or arbitration? <input type="checkbox"/> Yes <input type="checkbox"/> No		
Provide full details in a separate attachment if the response to any of these questions is Yes.		

8.03 List all projects currently under contract in Schedule A and provide indicated information.

8.04 List a minimum of three and a maximum of six projects completed in the last 5 years in Schedule B and provide indicated information to demonstrate the Business’s experience with projects similar in type and cost of construction.

8.05 In Schedule C, provide information on key individuals whom Business intends to assign to the Project. Provide resumes for those individuals included in Schedule C. Key individuals include the Project Manager, Project Superintendent, Quality Manager, and Safety Manager. Resumes may be provided for Business’s key leaders as well.

ARTICLE 9—REQUIRED ATTACHMENTS

9.01 Provide the following information with the Statement of Qualifications:

- A. If Business is a Joint Venture, separate Qualifications Statements for each Joint Venturer, as required in Paragraph 1.02.
- B. Certification of Business’s safety performance if required by Paragraph 4.02.
- C. Attachments providing additional information as required by Paragraph 8.02.
- D. Schedule A (Current Projects) as required by Paragraph 8.03.
- E. Schedule B (Previous Experience with Similar Projects) as required by Paragraph 8.04.
- F. Schedule C (Key Individuals) and resumes for the key individuals listed, as required by Paragraph 8.05.
- G. Additional items as pertinent.

This Statement of Qualifications is offered by:

Business: _____
(typed or printed name of organization)

By: _____
(individual's signature)

Name: _____
(typed or printed)

Title: _____
(typed or printed)

Date: _____
(date signed)

(If Business is a corporation, a partnership, or a joint venture, attach evidence of authority to sign.)

Attest: _____
(individual's signature)

Name: _____
(typed or printed)

Title: _____
(typed or printed)

Address for giving notices:

Designated Representative:

Name: _____
(typed or printed)

Title: _____
(typed or printed)

Address: _____

Phone: _____

Email: _____

Schedule A—Current Projects

Name of Organization					
Project Owner			Project Name		
General Description of Project					
Project Cost			Date Project		
Key Project Personnel	Project Manager	Project Superintendent	Safety Manager	Quality Control Manager	
Name					
Reference Contact Information (listing names indicates approval to contacting the names individuals as a reference)					
	Name	Title/Position	Organization	Telephone	Email
Owner					
Designer					
Construction Manager					

Project Owner			Project Name		
General Description of Project					
Project Cost			Date Project		
Key Project Personnel	Project Manager	Project Superintendent	Safety Manager	Quality Control Manager	
Name					
Reference Contact Information (listing names indicates approval to contacting the names individuals as a reference)					
	Name	Title/Position	Organization	Telephone	Email
Owner					
Designer					
Construction Manager					

Project Owner			Project Name		
General Description of Project					
Project Cost			Date Project		
Key Project Personnel	Project Manager	Project Superintendent	Safety Manager	Quality Control Manager	
Name					
Reference Contact Information (listing names indicates approval to contacting the names individuals as a reference)					
	Name	Title/Position	Organization	Telephone	Email
Owner					
Designer					
Construction Manager					

Schedule B—Previous Experience with Similar Projects

Name of Organization					
Project Owner			Project Name		
General Description of Project					
Project Cost			Date Project		
Key Project Personnel	Project Manager	Project Superintendent	Safety Manager	Quality Control Manager	
Name					
Reference Contact Information (listing names indicates approval to contacting the names individuals as a reference)					
	Name	Title/Position	Organization	Telephone	Email
Owner					
Designer					
Construction Manager					

Project Owner			Project Name		
General Description of Project					
Project Cost			Date Project		
Key Project Personnel	Project Manager	Project Superintendent	Safety Manager	Quality Control Manager	
Name					
Reference Contact Information (listing names indicates approval to contacting the names individuals as a reference)					
	Name	Title/Position	Organization	Telephone	Email
Owner					
Designer					
Construction Manager					

Project Owner			Project Name		
General Description of Project					
Project Cost			Date Project		
Key Project Personnel	Project Manager	Project Superintendent	Safety Manager	Quality Control Manager	
Name					
Reference Contact Information (listing names indicates approval to contacting the names individuals as a reference)					
	Name	Title/Position	Organization	Telephone	Email
Owner					
Designer					
Construction Manager					

Schedule B—Previous Experience with Similar Projects

Name of Organization					
Project Owner			Project Name		
General Description of Project					
Project Cost			Date Project		
Key Project Personnel	Project Manager	Project Superintendent	Safety Manager	Quality Control Manager	
Name					
Reference Contact Information (listing names indicates approval to contacting the names individuals as a reference)					
	Name	Title/Position	Organization	Telephone	Email
Owner					
Designer					
Construction Manager					

Project Owner			Project Name		
General Description of Project					
Project Cost			Date Project		
Key Project Personnel	Project Manager	Project Superintendent	Safety Manager	Quality Control Manager	
Name					
Reference Contact Information (listing names indicates approval to contacting the names individuals as a reference)					
	Name	Title/Position	Organization	Telephone	Email
Owner					
Designer					
Construction Manager					

Project Owner			Project Name		
General Description of Project					
Project Cost			Date Project		
Key Project Personnel	Project Manager	Project Superintendent	Safety Manager	Quality Control Manager	
Name					
Reference Contact Information (listing names indicates approval to contacting the names individuals as a reference)					
	Name	Title/Position	Organization	Telephone	Email
Owner					
Designer					
Construction Manager					

Schedule C—Key Individuals

Project Manager			
Name of individual			
Years of experience as project manager			
Years of experience with this organization			
Number of similar projects as project manager			
Number of similar projects in other positions			
Current Project Assignments			
Name of assignment		Percent of time used for this project	Estimated project completion date
Reference Contact Information (listing names indicates approval to contact named individuals as a reference)			
Name		Name	
Title/Position		Title/Position	
Organization		Organization	
Telephone		Telephone	
Email		Email	
Project		Project	
Candidate's role on project		Candidate's role on project	
Project Superintendent			
Name of individual			
Years of experience as project superintendent			
Years of experience with this organization			
Number of similar projects as project superintendent			
Number of similar projects in other positions			
Current Project Assignments			
Name of assignment		Percent of time used for this project	Estimated project completion date
Reference Contact Information (listing names indicates approval to contact named individuals as a reference)			
Name		Name	
Title/Position		Title/Position	
Organization		Organization	
Telephone		Telephone	
Email		Email	
Project		Project	
Candidate's role on project		Candidate's role on project	

Safety Manager			
Name of individual			
Years of experience as project manager			
Years of experience with this organization			
Number of similar projects as project manager			
Number of similar projects in other positions			
Current Project Assignments			
Name of assignment		Percent of time used for this project	Estimated project completion date
Reference Contact Information (listing names indicates approval to contact named individuals as a reference)			
Name		Name	
Title/Position		Title/Position	
Organization		Organization	
Telephone		Telephone	
Email		Email	
Project		Project	
Candidate's role on project		Candidate's role on project	
Quality Control Manager			
Name of individual			
Years of experience as project superintendent			
Years of experience with this organization			
Number of similar projects as project superintendent			
Number of similar projects in other positions			
Current Project Assignments			
Name of assignment		Percent of time used for this project	Estimated project completion date
Reference Contact Information (listing names indicates approval to contact named individuals as a reference)			
Name		Name	
Title/Position		Title/Position	
Organization		Organization	
Telephone		Telephone	
Email		Email	
Project		Project	
Candidate's role on project		Candidate's role on project	

NOTICE OF AWARD

Date of Issuance:

Owner: City of Mandan Owner’s Project No.: 1062
Engineer: AE2S Engineer’s Project No.: P00510-2026-002
Project: Mandan South Side Reservoir Coating
Contract Name: Contract No. 1 – General Construction
Bidder:
Bidder’s Address:

You are notified that Owner has accepted your Bid dated **[date]** for the above Contract, and that you are the Successful Bidder and are awarded a Contract for Contract No. 1 – General Construction - surface preparation and coating of City of Mandan’s South side Reservoir.

The Contract Price of the awarded Contract is **\$(Contract Price)**. Contract Price is subject to adjustment based on the provisions of the Contract, including but not limited to those governing changes, Unit Price Work, and Work performed on a cost-plus-fee basis, as applicable.

One (1) unexecuted counterpart of the Agreement accompany this Notice of Award, and one copy of the Contract Documents accompanies this Notice of Award, or has been transmitted or made available to Bidder electronically.

You must comply with the following conditions precedent within 15 days of the date of receipt of this Notice of Award:

1. Deliver to Owner **one (1)** counterparts of the Agreement, signed by Bidder (as Contractor) in electronic digital format (PDF).
2. Deliver with the signed Agreement(s) the Contract security (such as required performance and payment bonds) and insurance documentation, as specified in the Instructions to Bidders and in the General Conditions, Articles 2 and 6.
3. Other conditions precedent (if any):
 - a. **Deliver current Workman’s Compensation Certificate of Premium Paid.**
 - b. **Deliver Contractor’s Certificate of North Dakota Income and Sales Tax Clearance.**

Failure to comply with these conditions within the time specified will entitle Owner to consider you in default, annul this Notice of Award, and declare your Bid security forfeited.

Within 10 days after you comply with the above conditions, Owner will return to you one fully signed counterpart of the Agreement, together with any additional copies of the Contract Documents as indicated in Paragraph 2.02 of the General Conditions.

Owner: **City of Mandan**

By (signature): _____

Name (printed): James Froelich

Title: Mayor

Copy: Engineer

This page intentionally left blank

AGREEMENT BETWEEN OWNER AND CONTRACTOR FOR CONSTRUCTION CONTRACT (STIPULATED PRICE)

This Agreement is by and between City of Mandan (“Owner”) and [name of contracting entity] (“Contractor”).

Terms used in this Agreement have the meanings stated in the General Conditions and the Supplementary Conditions.

Owner and Contractor hereby agree as follows:

ARTICLE 1—WORK

1.01 Contractor shall complete all Work as specified or indicated in the Contract Documents. The Work is generally described as follows: **Contract No. 1 – General Construction – Surface preparation and coating of exterior walls and dome of the City of Mandan’s South Side Reservoir.**

ARTICLE 2—THE PROJECT

2.01 The Project, of which the Work under the Contract Documents is a part, is generally described as follows: **Mandan South Side Reservoir Coating**

ARTICLE 3—ENGINEER

3.01 The Owner has retained Advanced Engineering and Environmental Services, LLC (AE2S) (“Engineer”) to act as Owner’s representative, assume all duties and responsibilities of Engineer, and have the rights and authority assigned to Engineer in the Contract.

3.02 The part of the Project that pertains to the Work has been designed by Engineer.

ARTICLE 4—CONTRACT TIMES

4.01 *Time is of the Essence*

A. All time limits for Milestones, if any, Substantial Completion, and completion and readiness for final payment as stated in the Contract Documents are of the essence of the Contract.

4.02 *Contract Times: Dates*

A. The Work will be substantially complete on or before **September 30th, 2026**, and completed and ready for final payment in accordance with Paragraph 15.06 of the General Conditions on or before **October 15th, 2026**.

4.05 *Liquidated Damages*

A. Contractor and Owner recognize that time is of the essence as stated in Paragraph 4.01 above and that Owner will suffer financial and other losses if the Work is not completed and Milestones not achieved within the Contract Times, as duly modified. The parties also recognize the delays, expense, and difficulties involved in proving, in a legal or arbitration proceeding, the actual loss suffered by Owner if the Work is not completed on time. Accordingly, instead of requiring any such proof, Owner and Contractor agree that as liquidated damages for delay (but not as a penalty):

1. *Completion of Remaining Work:* If Contractor shall neglect, refuse, or fail to complete the remaining Work within the Contract Times (as duly adjusted pursuant to the Contract) for completion and readiness for final payment, Contractor shall pay Owner \$500.00 for each day that expires after such time until the Work is completed and ready for final payment.
 2. Liquidated damages for failing to timely attain Milestones, Substantial Completion, and final completion are not additive, and will not be imposed concurrently.
- B. If Owner recovers liquidated damages for a delay in completion by Contractor, then such liquidated damages are Owner's sole and exclusive remedy for such delay, and Owner is precluded from recovering any other damages, whether actual, direct, excess, or consequential, for such delay, except for special damages (if any) specified in this Agreement.

ARTICLE 5—CONTRACT PRICE

5.01 Owner shall pay Contractor for completion of the Work in accordance with the Contract Documents, the amounts that follow, subject to adjustment under the Contract:

- A. For all Work other than Unit Price Work, a lump sum of \$[number].

All specific cash allowances are included in the above price in accordance with Paragraph 13.02 of the General Conditions.

ARTICLE 6—PAYMENT PROCEDURES

6.01 *Submittal and Processing of Payments*

- A. Contractor shall submit Applications for Payment in accordance with Article 15 of the General Conditions. Applications for Payment will be processed by Engineer as provided in the General Conditions.

6.02 *Progress Payments; Retainage*

- A. Owner shall make progress payments on the basis of Contractor's Applications for Payment on or about the 20th day of each month during performance of the Work as provided in Paragraph 6.02.A.1 below, provided that such Applications for Payment have been submitted in a timely manner and otherwise meet the requirements of the Contract. All such payments will be measured by the Schedule of Values established as provided in the General Conditions (and in the case of Unit Price Work based on the number of units completed) or, in the event there is no Schedule of Values, as provided elsewhere in the Contract.

1. Prior to Substantial Completion, progress payments will be made in an amount equal to the percentage indicated below but, in each case, less the aggregate of payments previously made and less such amounts as Owner may withhold, including but not limited to liquidated damages, in accordance with the Contract.

- a. 90 percent of the value of the Work completed (with the balance being retainage).

- 1) If 50 percent or more of the Work has been completed, as determined by Engineer, and if the character and progress of the Work have been satisfactory to Owner and Engineer, then as long as the character and progress of the Work remain satisfactory to Owner and Engineer, there will be no additional retainage; and

- b. 90 percent of cost of materials and equipment not incorporated in the Work (with the balance being retainage).
 - B. Upon Substantial Completion, Owner shall pay an amount sufficient to increase total payments to Contractor to 95 percent of the Work completed, less such amounts set off by Owner pursuant to Paragraph 15.01.E of the General Conditions, and less 200 percent of Engineer's estimate of the value of Work to be completed or corrected as shown on the punch list of items to be completed or corrected prior to final payment.
- 6.03 *Final Payment*
- A. Upon final completion and acceptance of the Work, Owner shall pay the remainder of the Contract Price in accordance with Paragraph 15.06 of the General Conditions.
- 6.04 *Consent of Surety*
- A. Owner will not make final payment, or return or release retainage at Substantial Completion or any other time, unless Contractor submits written consent of the surety to such payment, return, or release.
- 6.05 *Interest*
- A. All amounts not paid when due will bear interest at the rate interest requirements of the North Dakota Century Code Chapter 48-01.2-14.

ARTICLE 7—CONTRACT DOCUMENTS

- 7.01 *Contents*
- A. The Contract Documents consist of all of the following:
 - 1. This Agreement.
 - 2. Bonds:
 - a. Performance bond (together with power of attorney).
 - b. Payment bond (together with power of attorney).
 - 3. General Conditions.
 - 4. Supplementary Conditions.
 - 5.
 - 6. Specifications as listed in the table of contents of the project manual
 - 7. Addenda (numbers **[number]** to **[number]**, inclusive).
 - 8. Exhibits to this Agreement (enumerated as follows):
 - a. **[list exhibits]**
 - 9. The following which may be delivered or issued on or after the Effective Date of the Contract and are not attached hereto:
 - a. Notice to Proceed.
 - b. Work Change Directives.
 - c. Change Orders.

- d. Field Orders.
- e. Warranty Bond, if any.
- B. The Contract Documents listed in Paragraph 7.01.A are attached to this Agreement (except as expressly noted otherwise above).
- C. There are no Contract Documents other than those listed above in this Article 7.
- D. The Contract Documents may only be amended, modified, or supplemented as provided in the Contract.

ARTICLE 8—REPRESENTATIONS, CERTIFICATIONS, AND STIPULATIONS

8.01 Contractor's Representations

- A. In order to induce Owner to enter into this Contract, Contractor makes the following representations:
 - 1. Contractor has examined and carefully studied the Contract Documents, including Addenda.
 - 2. Contractor has visited the Site, conducted a thorough visual examination of the Site and adjacent areas, and become familiar with the general, local, and Site conditions that may affect cost, progress, and performance of the Work.
 - 3. Contractor is familiar with all Laws and Regulations that may affect cost, progress, and performance of the Work.
 - 4. Contractor has carefully studied the reports of explorations and tests of subsurface conditions at or adjacent to the Site and the drawings of physical conditions relating to existing surface or subsurface structures at the Site that have been identified in the Supplementary Conditions, with respect to the Technical Data in such reports and drawings.
 - 5. Contractor has carefully studied the reports and drawings relating to Hazardous Environmental Conditions, if any, at or adjacent to the Site that have been identified in the Supplementary Conditions, with respect to Technical Data in such reports and drawings.
 - 6. Contractor has considered the information known to Contractor itself; information commonly known to contractors doing business in the locality of the Site; information and observations obtained from visits to the Site; the Contract Documents; and the Technical Data identified in the Supplementary Conditions or by definition, with respect to the effect of such information, observations, and Technical Data on (a) the cost, progress, and performance of the Work; (b) the means, methods, techniques, sequences, and procedures of construction to be employed by Contractor; and (c) Contractor's safety precautions and programs.
 - 7. Based on the information and observations referred to in the preceding paragraph, Contractor agrees that no further examinations, investigations, explorations, tests, studies, or data are necessary for the performance of the Work at the Contract Price, within the Contract Times, and in accordance with the other terms and conditions of the Contract.

8. Contractor is aware of the general nature of work to be performed by Owner and others at the Site that relates to the Work as indicated in the Contract Documents.
9. Contractor has given Engineer written notice of all conflicts, errors, ambiguities, or discrepancies that Contractor has discovered in the Contract Documents, and of discrepancies between Site conditions and the Contract Documents, and the written resolution thereof by Engineer is acceptable to Contractor.
10. The Contract Documents are generally sufficient to indicate and convey understanding of all terms and conditions for performance and furnishing of the Work.
11. Contractor's entry into this Contract constitutes an incontrovertible representation by Contractor that without exception all prices in the Agreement are premised upon performing and furnishing the Work required by the Contract Documents.

8.02 *Contractor's Certifications*

- A. Contractor certifies that it has not engaged in corrupt, fraudulent, collusive, or coercive practices in competing for or in executing the Contract. For the purposes of this Paragraph 8.02:
 1. "corrupt practice" means the offering, giving, receiving, or soliciting of anything of value likely to influence the action of a public official in the bidding process or in the Contract execution;
 2. "fraudulent practice" means an intentional misrepresentation of facts made (a) to influence the bidding process or the execution of the Contract to the detriment of Owner, (b) to establish Bid or Contract prices at artificial non-competitive levels, or (c) to deprive Owner of the benefits of free and open competition;
 3. "collusive practice" means a scheme or arrangement between two or more Bidders, with or without the knowledge of Owner, a purpose of which is to establish Bid prices at artificial, non-competitive levels; and
 4. "coercive practice" means harming or threatening to harm, directly or indirectly, persons or their property to influence their participation in the bidding process or affect the execution of the Contract.

8.03 *Standard General Conditions*

- A. Owner stipulates that if the General Conditions that are made a part of this Contract are EJCDC® C-700, Standard General Conditions for the Construction Contract (2018), published by the Engineers Joint Contract Documents Committee, and if Owner is the party that has furnished said General Conditions, then Owner has plainly shown all modifications to the standard wording of such published document to the Contractor, through a process such as highlighting or "track changes" (redline/strikeout), or in the Supplementary Conditions.

IN WITNESS WHEREOF, Owner and Contractor have signed this Agreement.

This Agreement will be effective on **[indicate date on which Contract becomes effective]** (which is the Effective Date of the Contract).

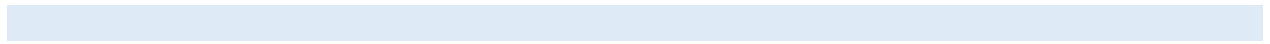

Owner:
City of Mandan

(typed or printed name of organization)

By: Jarek Wigness

(individual's signature)

Date: _____
(date signed)

Name: _____
(typed or printed)

Title: City Engineer

(typed or printed)

Attest: _____
(individual's signature)

Title: _____
(typed or printed)

Address for giving notices:
205 2nd Ave. NW

Mandan, ND 58554

Designated Representative:

Name: Duane Friesz

(typed or printed)

Title: WTP Superintendent

(typed or printed)

Address:
1994 38th St.

Mandan, ND 52554

Phone: 701-667-3275

Email: mandanwtp@midconetwork.com

(If [Type of Entity] is a corporation, attach evidence of authority to sign. If [Type of Entity] is a public body, attach evidence of authority to sign and resolution or other documents authorizing execution of this Agreement.)

Contractor:

(typed or printed name of organization)

By: _____
(individual's signature)

Date: _____
(date signed)

Name: _____
(typed or printed)

Title: _____
(typed or printed)

(If [Type of Entity] is a corporation, a partnership, or a joint venture, attach evidence of authority to sign.)

Attest: _____
(individual's signature)

Title: _____
(typed or printed)

Address for giving notices:

Designated Representative:

Name: _____
(typed or printed)

Title: _____
(typed or printed)

Address:

Phone: _____

Email: _____

License No.: _____
(where applicable)

State: _____

NOTICE TO PROCEED

Owner: City of Mandan Owner's Project No.: 1062
Engineer: AE2S Engineer's Project No.: P00510-2026-002
Contractor: _____ Contractor's Project No.: _____
Project: Mandan South Side Reservoir Coating
Contract Name: Contract No. 1 – General Construction
Effective Date of Contract: _____

Owner hereby notifies Contractor that the Contract Times under the above Contract will commence to run on **[date Contract Times are to start]** pursuant to Paragraph 4.01 of the General Conditions.

On that date, Contractor shall start performing its obligations under the Contract Documents. No Work will be done at the Site prior to such date.

In accordance with the Agreement:

The date by which Substantial Completion must be achieved is **September 30th, 2026**, and the date by which readiness for final payment must be achieved is **October 15th, 2026**.

Before starting any Work at the Site, Contractor must comply with the following:

None.

Owner: City of Mandan
By *(signature)*: _____
Name *(printed)*: Jarek Wigness
Title: City Engineer
Date Issued: _____

Copy: Engineer

This page intentionally left blank

PERFORMANCE BOND

<p>Contractor</p> <p>Name: _____</p> <p>Address <i>(principal place of business)</i>: _____</p>	<p>Surety</p> <p>Name: _____</p> <p>Address <i>(principal place of business)</i>: _____</p>
<p>Owner</p> <p>Name: City of Mandan</p> <p>Mailing address <i>(principal place of business)</i>: 205 2nd Avenue NW Mandan, ND 58554</p>	<p>Contract</p> <p>Description <i>(name and location)</i>: Mandan South Side Reservoir Coating Mandan, ND</p> <p>Contract Price: _____</p> <p>Effective Date of Contract: _____</p>
<p>Bond</p> <p>Bond Amount: _____</p> <p>Date of Bond: _____ <i>(Date of Bond cannot be earlier than Effective Date of Contract)</i></p> <p>Modifications to this Bond form: <input type="checkbox"/> None <input type="checkbox"/> See Paragraph 16</p>	
<p>Surety and Contractor, intending to be legally bound hereby, subject to the terms set forth in this Performance Bond, do each cause this Performance Bond to be duly executed by an authorized officer, agent, or representative.</p>	
Contractor as Principal	Surety
_____ <i>(Full formal name of Contractor)</i>	_____ <i>(Full formal name of Surety) (corporate seal)</i>
By: _____ <i>(Signature)</i>	By: _____ <i>(Signature)(Attach Power of Attorney)</i>
Name: _____ <i>(Printed or typed)</i>	Name: _____ <i>(Printed or typed)</i>
Title: _____	Title: _____
Attest: _____ <i>(Signature)</i>	Attest: _____ <i>(Signature)</i>
Name: _____ <i>(Printed or typed)</i>	Name: _____ <i>(Printed or typed)</i>
Title: _____	Title: _____
<p><i>Notes: (1) Provide supplemental execution by any additional parties, such as joint venturers. (2) Any singular reference to Contractor, Surety, Owner, or other party is considered plural where applicable.</i></p>	

1. The Contractor and Surety, jointly and severally, bind themselves, their heirs, executors, administrators, successors, and assigns to the Owner for the performance of the Construction Contract, which is incorporated herein by reference.
2. If the Contractor performs the Construction Contract, the Surety and the Contractor shall have no obligation under this Bond, except when applicable to participate in a conference as provided in Paragraph 3.
3. If there is no Owner Default under the Construction Contract, the Surety's obligation under this Bond will arise after:
 - 3.1. The Owner first provides notice to the Contractor and the Surety that the Owner is considering declaring a Contractor Default. Such notice may indicate whether the Owner is requesting a conference among the Owner, Contractor, and Surety to discuss the Contractor's performance. If the Owner does not request a conference, the Surety may, within five (5) business days after receipt of the Owner's notice, request such a conference. If the Surety timely requests a conference, the Owner shall attend. Unless the Owner agrees otherwise, any conference requested under this Paragraph 3.1 will be held within ten (10) business days of the Surety's receipt of the Owner's notice. If the Owner, the Contractor, and the Surety agree, the Contractor shall be allowed a reasonable time to perform the Construction Contract, but such an agreement does not waive the Owner's right, if any, subsequently to declare a Contractor Default;
 - 3.2. The Owner declares a Contractor Default, terminates the Construction Contract and notifies the Surety; and
 - 3.3. The Owner has agreed to pay the Balance of the Contract Price in accordance with the terms of the Construction Contract to the Surety or to a contractor selected to perform the Construction Contract.
4. Failure on the part of the Owner to comply with the notice requirement in Paragraph 3.1 does not constitute a failure to comply with a condition precedent to the Surety's obligations, or release the Surety from its obligations, except to the extent the Surety demonstrates actual prejudice.
5. When the Owner has satisfied the conditions of Paragraph 3, the Surety shall promptly and at the Surety's expense take one of the following actions:
 - 5.1. Arrange for the Contractor, with the consent of the Owner, to perform and complete the Construction Contract;
 - 5.2. Undertake to perform and complete the Construction Contract itself, through its agents or independent contractors;
 - 5.3. Obtain bids or negotiated proposals from qualified contractors acceptable to the Owner for a contract for performance and completion of the Construction Contract, arrange for a contract to be prepared for execution by the Owner and a contractor selected with the Owners concurrence, to be secured with performance and payment bonds executed by a qualified surety equivalent to the bonds issued on the Construction Contract, and pay to the Owner the amount of damages as described in Paragraph 7 in excess of the Balance of the Contract Price incurred by the Owner as a result of the Contractor Default; or
 - 5.4. Waive its right to perform and complete, arrange for completion, or obtain a new contractor, and with reasonable promptness under the circumstances:

- 5.4.1 After investigation, determine the amount for which it may be liable to the Owner and, as soon as practicable after the amount is determined, make payment to the Owner; or
 - 5.4.2 Deny liability in whole or in part and notify the Owner, citing the reasons for denial.
6. If the Surety does not proceed as provided in Paragraph 5 with reasonable promptness, the Surety shall be deemed to be in default on this Bond seven days after receipt of an additional written notice from the Owner to the Surety demanding that the Surety perform its obligations under this Bond, and the Owner shall be entitled to enforce any remedy available to the Owner. If the Surety proceeds as provided in Paragraph 5.4, and the Owner refuses the payment, or the Surety has denied liability, in whole or in part, without further notice, the Owner shall be entitled to enforce any remedy available to the Owner.
7. If the Surety elects to act under Paragraph 5.1, 5.2, or 5.3, then the responsibilities of the Surety to the Owner will not be greater than those of the Contractor under the Construction Contract, and the responsibilities of the Owner to the Surety will not be greater than those of the Owner under the Construction Contract. Subject to the commitment by the Owner to pay the Balance of the Contract Price, the Surety is obligated, without duplication for:
 - 7.1. the responsibilities of the Contractor for correction of defective work and completion of the Construction Contract;
 - 7.2. additional legal, design professional, and delay costs resulting from the Contractor's Default, and resulting from the actions or failure to act of the Surety under Paragraph 5; and
 - 7.3. liquidated damages, or if no liquidated damages are specified in the Construction Contract, actual damages caused by delayed performance or non-performance of the Contractor.
8. If the Surety elects to act under Paragraph 5.1, 5.3, or 5.4, the Surety's liability is limited to the amount of this Bond.
9. The Surety shall not be liable to the Owner or others for obligations of the Contractor that are unrelated to the Construction Contract, and the Balance of the Contract Price will not be reduced or set off on account of any such unrelated obligations. No right of action will accrue on this Bond to any person or entity other than the Owner or its heirs, executors, administrators, successors, and assigns.
10. The Surety hereby waives notice of any change, including changes of time, to the Construction Contract or to related subcontracts, purchase orders, and other obligations.
11. Any proceeding, legal or equitable, under this Bond must be instituted in any court of competent jurisdiction in the location in which the work or part of the work is located and must be instituted within two years after a declaration of Contractor Default or within two years after the Contractor ceased working or within two years after the Surety refuses or fails to perform its obligations under this Bond, whichever occurs first. If the provisions of this paragraph are void or prohibited by law, the minimum periods of limitations available to sureties as a defense in the jurisdiction of the suit will be applicable.
12. Notice to the Surety, the Owner, or the Contractor must be mailed or delivered to the address shown on the page on which their signature appears.
13. When this Bond has been furnished to comply with a statutory or other legal requirement in the location where the construction was to be performed, any provision in this Bond conflicting with said statutory or legal requirement will be deemed deleted therefrom and provisions conforming to such

statutory or other legal requirement will be deemed incorporated herein. When so furnished, the intent is that this Bond will be construed as a statutory bond and not as a common law bond.

14. Definitions

- 14.1. *Balance of the Contract Price*—The total amount payable by the Owner to the Contractor under the Construction Contract after all proper adjustments have been made including allowance for the Contractor for any amounts received or to be received by the Owner in settlement of insurance or other claims for damages to which the Contractor is entitled, reduced by all valid and proper payments made to or on behalf of the Contractor under the Construction Contract.
 - 14.2. *Construction Contract*—The agreement between the Owner and Contractor identified on the cover page, including all Contract Documents and changes made to the agreement and the Contract Documents.
 - 14.3. *Contractor Default*—Failure of the Contractor, which has not been remedied or waived, to perform or otherwise to comply with a material term of the Construction Contract.
 - 14.4. *Owner Default*—Failure of the Owner, which has not been remedied or waived, to pay the Contractor as required under the Construction Contract or to perform and complete or comply with the other material terms of the Construction Contract.
 - 14.5. *Contract Documents*—All the documents that comprise the agreement between the Owner and Contractor.
15. If this Bond is issued for an agreement between a contractor and subcontractor, the term Contractor in this Bond will be deemed to be Subcontractor and the term Owner will be deemed to be Contractor.
16. Modifications to this Bond are as follows: None.

PAYMENT BOND

<p>Contractor</p> <p>Name: _____</p> <p>Address <i>(principal place of business)</i>: _____</p>	<p>Surety</p> <p>Name: _____</p> <p>Address <i>(principal place of business)</i>: _____</p>
<p>Owner</p> <p>Name: City of Mandan</p> <p>Mailing address <i>(principal place of business)</i>: 205 2nd Avenue NW Mandan, ND 58554</p>	<p>Contract</p> <p>Description <i>(name and location)</i>: Mandan South Side Reservoir Coating Mandan, ND</p> <p>Contract Price: _____</p> <p>Effective Date of Contract: _____</p>
<p>Bond</p> <p>Bond Amount: _____</p> <p>Date of Bond: _____ <i>(Date of Bond cannot be earlier than Effective Date of Contract)</i></p> <p>Modifications to this Bond form: <input type="checkbox"/> None <input type="checkbox"/> See Paragraph 18</p>	
<p>Surety and Contractor, intending to be legally bound hereby, subject to the terms set forth in this Payment Bond, do each cause this Payment Bond to be duly executed by an authorized officer, agent, or representative.</p>	
Contractor as Principal	Surety
_____ <i>(Full formal name of Contractor)</i>	_____ <i>(Full formal name of Surety) (corporate seal)</i>
By: _____ <i>(Signature)</i>	By: _____ <i>(Signature)(Attach Power of Attorney)</i>
Name: _____ <i>(Printed or typed)</i>	Name: _____ <i>(Printed or typed)</i>
Title: _____	Title: _____
Attest: _____ <i>(Signature)</i>	Attest: _____ <i>(Signature)</i>
Name: _____ <i>(Printed or typed)</i>	Name: _____ <i>(Printed or typed)</i>
Title: _____	Title: _____
<p><i>Notes: (1) Provide supplemental execution by any additional parties, such as joint venturers. (2) Any singular reference to Contractor, Surety, Owner, or other party is considered plural where applicable.</i></p>	

1. The Contractor and Surety, jointly and severally, bind themselves, their heirs, executors, administrators, successors, and assigns to the Owner to pay for labor, materials, and equipment furnished for use in the performance of the Construction Contract, which is incorporated herein by reference, subject to the following terms.
2. If the Contractor promptly makes payment of all sums due to Claimants, and defends, indemnifies, and holds harmless the Owner from claims, demands, liens, or suits by any person or entity seeking payment for labor, materials, or equipment furnished for use in the performance of the Construction Contract, then the Surety and the Contractor shall have no obligation under this Bond.
3. If there is no Owner Default under the Construction Contract, the Surety's obligation to the Owner under this Bond will arise after the Owner has promptly notified the Contractor and the Surety (at the address described in Paragraph 13) of claims, demands, liens, or suits against the Owner or the Owner's property by any person or entity seeking payment for labor, materials, or equipment furnished for use in the performance of the Construction Contract, and tendered defense of such claims, demands, liens, or suits to the Contractor and the Surety.
4. When the Owner has satisfied the conditions in Paragraph 3, the Surety shall promptly and at the Surety's expense defend, indemnify, and hold harmless the Owner against a duly tendered claim, demand, lien, or suit.
5. The Surety's obligations to a Claimant under this Bond will arise after the following:
 - 5.1. Claimants who do not have a direct contract with the Contractor
 - 5.1.1. have furnished a written notice of non-payment to the Contractor, stating with substantial accuracy the amount claimed and the name of the party to whom the materials were, or equipment was, furnished or supplied or for whom the labor was done or performed, within ninety (90) days after having last performed labor or last furnished materials or equipment included in the Claim; and
 - 5.1.2. have sent a Claim to the Surety (at the address described in Paragraph 13).
 - 5.2. Claimants who are employed by or have a direct contract with the Contractor have sent a Claim to the Surety (at the address described in Paragraph 13).
6. If a notice of non-payment required by Paragraph 5.1.1 is given by the Owner to the Contractor, that is sufficient to satisfy a Claimant's obligation to furnish a written notice of non-payment under Paragraph 5.1.1.
7. When a Claimant has satisfied the conditions of Paragraph 5.1 or 5.2, whichever is applicable, the Surety shall promptly and at the Surety's expense take the following actions:
 - 7.1. Send an answer to the Claimant, with a copy to the Owner, within sixty (60) days after receipt of the Claim, stating the amounts that are undisputed and the basis for challenging any amounts that are disputed; and
 - 7.2. Pay or arrange for payment of any undisputed amounts.
 - 7.3. The Surety's failure to discharge its obligations under Paragraph 7.1 or 7.2 will not be deemed to constitute a waiver of defenses the Surety or Contractor may have or acquire as to a Claim, except as to undisputed amounts for which the Surety and Claimant have reached agreement. If, however, the Surety fails to discharge its obligations under Paragraph 7.1 or 7.2, the Surety shall indemnify the Claimant for the reasonable attorney's fees the Claimant incurs thereafter to recover any sums found to be due and owing to the Claimant.

8. The Surety's total obligation will not exceed the amount of this Bond, plus the amount of reasonable attorney's fees provided under Paragraph 7.3, and the amount of this Bond will be credited for any payments made in good faith by the Surety.
9. Amounts owed by the Owner to the Contractor under the Construction Contract will be used for the performance of the Construction Contract and to satisfy claims, if any, under any construction performance bond. By the Contractor furnishing and the Owner accepting this Bond, they agree that all funds earned by the Contractor in the performance of the Construction Contract are dedicated to satisfying obligations of the Contractor and Surety under this Bond, subject to the Owner's priority to use the funds for the completion of the work.
10. The Surety shall not be liable to the Owner, Claimants, or others for obligations of the Contractor that are unrelated to the Construction Contract. The Owner shall not be liable for the payment of any costs or expenses of any Claimant under this Bond, and shall have under this Bond no obligation to make payments to or give notice on behalf of Claimants, or otherwise have any obligations to Claimants under this Bond.
11. The Surety hereby waives notice of any change, including changes of time, to the Construction Contract or to related subcontracts, purchase orders, and other obligations.
12. No suit or action will be commenced by a Claimant under this Bond other than in a court of competent jurisdiction in the state in which the project that is the subject of the Construction Contract is located or after the expiration of one year from the date (1) on which the Claimant sent a Claim to the Surety pursuant to Paragraph 5.1.2 or 5.2, or (2) on which the last labor or service was performed by anyone or the last materials or equipment were furnished by anyone under the Construction Contract, whichever of (1) or (2) first occurs. If the provisions of this paragraph are void or prohibited by law, the minimum period of limitation available to sureties as a defense in the jurisdiction of the suit will be applicable.
13. Notice and Claims to the Surety, the Owner, or the Contractor must be mailed or delivered to the address shown on the page on which their signature appears. Actual receipt of notice or Claims, however accomplished, will be sufficient compliance as of the date received.
14. When this Bond has been furnished to comply with a statutory or other legal requirement in the location where the construction was to be performed, any provision in this Bond conflicting with said statutory or legal requirement will be deemed deleted here from and provisions conforming to such statutory or other legal requirement will be deemed incorporated herein. When so furnished, the intent is that this Bond will be construed as a statutory bond and not as a common law bond.
15. Upon requests by any person or entity appearing to be a potential beneficiary of this Bond, the Contractor and Owner shall promptly furnish a copy of this Bond or shall permit a copy to be made.
16. Definitions
 - 16.1. *Claim*—A written statement by the Claimant including at a minimum:
 - 16.1.1. The name of the Claimant;
 - 16.1.2. The name of the person for whom the labor was done, or materials or equipment furnished;
 - 16.1.3. A copy of the agreement or purchase order pursuant to which labor, materials, or equipment was furnished for use in the performance of the Construction Contract;
 - 16.1.4. A brief description of the labor, materials, or equipment furnished;

- 16.1.5. The date on which the Claimant last performed labor or last furnished materials or equipment for use in the performance of the Construction Contract;
 - 16.1.6. The total amount earned by the Claimant for labor, materials, or equipment furnished as of the date of the Claim;
 - 16.1.7. The total amount of previous payments received by the Claimant; and
 - 16.1.8. The total amount due and unpaid to the Claimant for labor, materials, or equipment furnished as of the date of the Claim.
- 16.2. *Claimant*—An individual or entity having a direct contract with the Contractor or with a subcontractor of the Contractor to furnish labor, materials, or equipment for use in the performance of the Construction Contract. The term Claimant also includes any individual or entity that has rightfully asserted a claim under an applicable mechanic’s lien or similar statute against the real property upon which the Project is located. The intent of this Bond is to include without limitation in the terms of “labor, materials, or equipment” that part of the water, gas, power, light, heat, oil, gasoline, telephone service, or rental equipment used in the Construction Contract, architectural and engineering services required for performance of the work of the Contractor and the Contractor’s subcontractors, and all other items for which a mechanic’s lien may be asserted in the jurisdiction where the labor, materials, or equipment were furnished.
- 16.3. *Construction Contract*—The agreement between the Owner and Contractor identified on the cover page, including all Contract Documents and all changes made to the agreement and the Contract Documents.
- 16.4. *Owner Default*—Failure of the Owner, which has not been remedied or waived, to pay the Contractor as required under the Construction Contract or to perform and complete or comply with the other material terms of the Construction Contract.
- 16.5. *Contract Documents*—All the documents that comprise the agreement between the Owner and Contractor.
17. If this Bond is issued for an agreement between a contractor and subcontractor, the term Contractor in this Bond will be deemed to be Subcontractor and the term Owner will be deemed to be Contractor.
18. Modifications to this Bond are as follows: None.

Contractor's Application for Payment

Owner: <u>City of Mandan</u>	Owner's Project No.: _____
Engineer: <u>AE2S</u>	Engineer's Project No.: _____
Contractor: _____	Contractor's Project No.: _____
Project: <u>Mandan South Side Reservoir Coating</u>	
Contract: _____	
Application No.: _____	Application Date: _____
Application Period: From _____ to _____	

1. Original Contract Price	\$	-
2. Net change by Change Orders	\$	-
3. Current Contract Price (Line 1 + Line 2)	\$	-
4. Total Work completed and materials stored to date (Sum of Column G Lump Sum Total and Column J Unit Price Total)	\$	-
5. Retainage		
a. _____ X \$ _____ Work Completed	\$	-
b. _____ X \$ _____ Stored Materials	\$	-
c. Total Retainage (Line 5.a + Line 5.b)	\$	-
6. Amount eligible to date (Line 4 - Line 5.c)	\$	-
7. Less previous payments (Line 6 from prior application)		
8. Amount due this application	\$	-
9. Balance to finish, including retainage (Line 3 - Line 4)	\$	-

Contractor's Certification

The undersigned Contractor certifies, to the best of its knowledge, the following:

(1) All previous progress payments received from Owner on account of Work done under the Contract have been applied on account to discharge Contractor's legitimate obligations incurred in connection with the Work covered by prior Applications for Payment;

(2) Title to all Work, materials and equipment incorporated in said Work, or otherwise listed in or covered by this Application for Payment, will pass to Owner at time of payment free and clear of all liens, security interests, and encumbrances (except such as are covered by a bond acceptable to Owner indemnifying Owner against any such liens, security interest, or encumbrances); and

(3) All the Work covered by this Application for Payment is in accordance with the Contract Documents and is not defective.

Contractor: _____

Signature: _____ **Date:** _____

Recommended by Engineer	Approved by Owner
By: _____	By: _____
Title: _____	Title: _____
Date: _____	Date: _____
Approved by Funding Agency	
By: _____	By: _____
Title: _____	Title: _____
Date: _____	Date: _____

This page intentionally left blank

This page intentionally left blank

This document has important legal consequences; consultation with an attorney is encouraged with respect to its use or modification. This document should be adapted to the particular circumstances of the contemplated Project and the controlling Laws and Regulations.

STANDARD GENERAL CONDITIONS OF THE CONSTRUCTION CONTRACT

Prepared By



Endorsed By



Copyright© 2018

National Society of Professional Engineers
1420 King Street, Alexandria, VA 22314-2794
(703) 684-2882
www.nspe.org

American Council of Engineering Companies
1015 15th Street N.W., Washington, DC 20005
(202) 347-7474
www.acec.org

American Society of Civil Engineers
1801 Alexander Bell Drive, Reston, VA 20191-4400
(800) 548-2723
www.asce.org

The copyright for this EJCDC document is owned jointly by the three sponsoring organizations listed above. The National Society of Professional Engineers is the Copyright Administrator for the EJCDC documents; please direct all inquiries regarding EJCDC copyrights to NSPE.

NOTE: EJCDC publications may be purchased at www.ejcdc.org, or from any of the sponsoring organizations above.

STANDARD GENERAL CONDITIONS OF THE CONSTRUCTION CONTRACT

TABLE OF CONTENTS

	Page
Article 1—Definitions and Terminology.....	1
1.01 Defined Terms.....	1
1.02 Terminology	6
Article 2—Preliminary Matters.....	7
2.01 Delivery of Performance and Payment Bonds; Evidence of Insurance.....	7
2.02 Copies of Documents	7
2.03 Before Starting Construction	7
2.04 Preconstruction Conference; Designation of Authorized Representatives.....	8
2.05 Acceptance of Schedules	8
2.06 Electronic Transmittals	8
Article 3—Contract Documents: Intent, Requirements, Reuse.....	9
3.01 Intent.....	9
3.02 Reference Standards.....	9
3.03 Reporting and Resolving Discrepancies	10
3.04 Requirements of the Contract Documents.....	10
3.05 Reuse of Documents.....	11
Article 4—Commencement and Progress of the Work	11
4.01 Commencement of Contract Times; Notice to Proceed.....	11
4.02 Starting the Work.....	11
4.03 Reference Points.....	11
4.04 Progress Schedule.....	12
4.05 Delays in Contractor’s Progress	12
Article 5—Site; Subsurface and Physical Conditions; Hazardous Environmental Conditions	13
5.01 Availability of Lands	13
5.02 Use of Site and Other Areas.....	14
5.03 Subsurface and Physical Conditions.....	15
5.04 Differing Subsurface or Physical Conditions	16

5.05	Underground Facilities.....	17
5.06	Hazardous Environmental Conditions at Site	19
Article 6—Bonds and Insurance.....		21
6.01	Performance, Payment, and Other Bonds.....	21
6.02	Insurance—General Provisions.....	22
6.03	Contractor’s Insurance.....	24
6.04	Builder’s Risk and Other Property Insurance.....	25
6.05	Property Losses; Subrogation	25
6.06	Receipt and Application of Property Insurance Proceeds	27
Article 7—Contractor’s Responsibilities		27
7.01	Contractor’s Means and Methods of Construction	27
7.02	Supervision and Superintendence	27
7.03	Labor; Working Hours	27
7.04	Services, Materials, and Equipment	28
7.05	“Or Equals”.....	28
7.06	Substitutes	29
7.07	Concerning Subcontractors and Suppliers.....	31
7.08	Patent Fees and Royalties.....	32
7.09	Permits	33
7.10	Taxes	33
7.11	Laws and Regulations.....	33
7.12	Record Documents.....	33
7.13	Safety and Protection	34
7.14	Hazard Communication Programs	35
7.15	Emergencies.....	35
7.16	Submittals	35
7.17	Contractor’s General Warranty and Guarantee	38
7.18	Indemnification	39
7.19	Delegation of Professional Design Services	39
Article 8—Other Work at the Site.....		40
8.01	Other Work	40
8.02	Coordination	41
8.03	Legal Relationships.....	41

Article 9—Owner’s Responsibilities	42
9.01 Communications to Contractor	42
9.02 Replacement of Engineer	42
9.03 Furnish Data	42
9.04 Pay When Due.....	42
9.05 Lands and Easements; Reports, Tests, and Drawings.....	43
9.06 Insurance.....	43
9.07 Change Orders	43
9.08 Inspections, Tests, and Approvals.....	43
9.09 Limitations on Owner’s Responsibilities	43
9.10 Undisclosed Hazardous Environmental Condition.....	43
9.11 Evidence of Financial Arrangements.....	43
9.12 Safety Programs	43
Article 10—Engineer’s Status During Construction	44
10.01 Owner’s Representative.....	44
10.02 Visits to Site.....	44
10.03 Resident Project Representative.....	44
10.04 Engineer’s Authority	44
10.05 Determinations for Unit Price Work	45
10.06 Decisions on Requirements of Contract Documents and Acceptability of Work	45
10.07 Limitations on Engineer’s Authority and Responsibilities	45
10.08 Compliance with Safety Program.....	45
Article 11—Changes to the Contract	46
11.01 Amending and Supplementing the Contract	46
11.02 Change Orders	46
11.03 Work Change Directives.....	46
11.04 Field Orders.....	47
11.05 Owner-Authorized Changes in the Work	47
11.06 Unauthorized Changes in the Work.....	47
11.07 Change of Contract Price	47
11.08 Change of Contract Times.....	49
11.09 Change Proposals.....	49
11.10 Notification to Surety.....	50

Article 12—Claims.....	50
12.01 Claims.....	50
Article 13—Cost of the Work; Allowances; Unit Price Work	51
13.01 Cost of the Work	51
13.02 Allowances	55
13.03 Unit Price Work.....	55
Article 14—Tests and Inspections; Correction, Removal, or Acceptance of Defective Work	56
14.01 Access to Work.....	56
14.02 Tests, Inspections, and Approvals.....	56
14.03 Defective Work	57
14.04 Acceptance of Defective Work.....	58
14.05 Uncovering Work	58
14.06 Owner May Stop the Work	58
14.07 Owner May Correct Defective Work.....	59
Article 15—Payments to Contractor; Set-Offs; Completion; Correction Period	59
15.01 Progress Payments.....	59
15.02 Contractor’s Warranty of Title	62
15.03 Substantial Completion.....	62
15.04 Partial Use or Occupancy	63
15.05 Final Inspection	64
15.06 Final Payment.....	64
15.07 Waiver of Claims	65
15.08 Correction Period.....	66
Article 16—Suspension of Work and Termination	67
16.01 Owner May Suspend Work	67
16.02 Owner May Terminate for Cause.....	67
16.03 Owner May Terminate for Convenience.....	68
16.04 Contractor May Stop Work or Terminate	68
Article 17—Final Resolution of Disputes	69
17.01 Methods and Procedures.....	69
Article 18—Miscellaneous	69
18.01 Giving Notice	69
18.02 Computation of Times.....	69

18.03	Cumulative Remedies	70
18.04	Limitation of Damages	70
18.05	No Waiver	70
18.06	Survival of Obligations	70
18.07	Controlling Law	70
18.08	Assignment of Contract.....	70
18.09	Successors and Assigns	70
18.10	Headings.....	70

STANDARD GENERAL CONDITIONS OF THE CONSTRUCTION CONTRACT

ARTICLE 1—DEFINITIONS AND TERMINOLOGY

1.01 *Defined Terms*

- A. Wherever used in the Bidding Requirements or Contract Documents, a term printed with initial capital letters, including the term's singular and plural forms, will have the meaning indicated in the definitions below. In addition to terms specifically defined, terms with initial capital letters in the Contract Documents include references to identified articles and paragraphs, and the titles of other documents or forms.
1. *Addenda*—Written or graphic instruments issued prior to the opening of Bids which clarify, correct, or change the Bidding Requirements or the proposed Contract Documents.
 2. *Agreement*—The written instrument, executed by Owner and Contractor, that sets forth the Contract Price and Contract Times, identifies the parties and the Engineer, and designates the specific items that are Contract Documents.
 3. *Application for Payment*—The document prepared by Contractor, in a form acceptable to Engineer, to request progress or final payments, and which is to be accompanied by such supporting documentation as is required by the Contract Documents.
 4. *Bid*—The offer of a Bidder submitted on the prescribed form setting forth the prices for the Work to be performed.
 5. *Bidder*—An individual or entity that submits a Bid to Owner.
 6. *Bidding Documents*—The Bidding Requirements, the proposed Contract Documents, and all Addenda.
 7. *Bidding Requirements*—The Advertisement or invitation to bid, Instructions to Bidders, Bid Bond or other Bid security, if any, the Bid Form, and the Bid with any attachments.
 8. *Change Order*—A document which is signed by Contractor and Owner and authorizes an addition, deletion, or revision in the Work or an adjustment in the Contract Price or the Contract Times, or other revision to the Contract, issued on or after the Effective Date of the Contract.
 9. *Change Proposal*—A written request by Contractor, duly submitted in compliance with the procedural requirements set forth herein, seeking an adjustment in Contract Price or Contract Times; contesting an initial decision by Engineer concerning the requirements of the Contract Documents or the acceptability of Work under the Contract Documents; challenging a set-off against payments due; or seeking other relief with respect to the terms of the Contract.
 10. *Claim*
 - a. A demand or assertion by Owner directly to Contractor, duly submitted in compliance with the procedural requirements set forth herein, seeking an adjustment of Contract Price or Contract Times; contesting an initial decision by Engineer concerning the

- requirements of the Contract Documents or the acceptability of Work under the Contract Documents; contesting Engineer's decision regarding a Change Proposal; seeking resolution of a contractual issue that Engineer has declined to address; or seeking other relief with respect to the terms of the Contract.
- b. A demand or assertion by Contractor directly to Owner, duly submitted in compliance with the procedural requirements set forth herein, contesting Engineer's decision regarding a Change Proposal, or seeking resolution of a contractual issue that Engineer has declined to address.
 - c. A demand or assertion by Owner or Contractor, duly submitted in compliance with the procedural requirements set forth herein, made pursuant to Paragraph 12.01.A.4, concerning disputes arising after Engineer has issued a recommendation of final payment.
 - d. A demand for money or services by a third party is not a Claim.
11. *Constituent of Concern*—Asbestos, petroleum, radioactive materials, polychlorinated biphenyls (PCBs), lead-based paint (as defined by the HUD/EPA standard), hazardous waste, and any substance, product, waste, or other material of any nature whatsoever that is or becomes listed, regulated, or addressed pursuant to Laws and Regulations regulating, relating to, or imposing liability or standards of conduct concerning, any hazardous, toxic, or dangerous waste, substance, or material.
 12. *Contract*—The entire and integrated written contract between Owner and Contractor concerning the Work.
 13. *Contract Documents*—Those items so designated in the Agreement, and which together comprise the Contract.
 14. *Contract Price*—The money that Owner has agreed to pay Contractor for completion of the Work in accordance with the Contract Documents.
 15. *Contract Times*—The number of days or the dates by which Contractor shall: (a) achieve Milestones, if any; (b) achieve Substantial Completion; and (c) complete the Work.
 16. *Contractor*—The individual or entity with which Owner has contracted for performance of the Work.
 17. *Cost of the Work*—See Paragraph 13.01 for definition.
 18. *Drawings*—The part of the Contract that graphically shows the scope, extent, and character of the Work to be performed by Contractor.
 19. *Effective Date of the Contract*—The date, indicated in the Agreement, on which the Contract becomes effective.
 20. *Electronic Document*—Any Project-related correspondence, attachments to correspondence, data, documents, drawings, information, or graphics, including but not limited to Shop Drawings and other Submittals, that are in an electronic or digital format.
 21. *Electronic Means*—Electronic mail (email), upload/download from a secure Project website, or other communications methods that allow: (a) the transmission or communication of Electronic Documents; (b) the documentation of transmissions, including sending and receipt; (c) printing of the transmitted Electronic Document by the

recipient; (d) the storage and archiving of the Electronic Document by sender and recipient; and (e) the use by recipient of the Electronic Document for purposes permitted by this Contract. Electronic Means does not include the use of text messaging, or of Facebook, Twitter, Instagram, or similar social media services for transmission of Electronic Documents.

22. *Engineer*—The individual or entity named as such in the Agreement.
23. *Field Order*—A written order issued by Engineer which requires minor changes in the Work but does not change the Contract Price or the Contract Times.
24. *Hazardous Environmental Condition*—The presence at the Site of Constituents of Concern in such quantities or circumstances that may present a danger to persons or property exposed thereto.
 - a. The presence at the Site of materials that are necessary for the execution of the Work, or that are to be incorporated into the Work, and that are controlled and contained pursuant to industry practices, Laws and Regulations, and the requirements of the Contract, is not a Hazardous Environmental Condition.
 - b. The presence of Constituents of Concern that are to be removed or remediated as part of the Work is not a Hazardous Environmental Condition.
 - c. The presence of Constituents of Concern as part of the routine, anticipated, and obvious working conditions at the Site, is not a Hazardous Environmental Condition.
25. *Laws and Regulations; Laws or Regulations*—Any and all applicable laws, statutes, rules, regulations, ordinances, codes, and binding decrees, resolutions, and orders of any and all governmental bodies, agencies, authorities, and courts having jurisdiction.
26. *Liens*—Charges, security interests, or encumbrances upon Contract-related funds, real property, or personal property.
27. *Milestone*—A principal event in the performance of the Work that the Contract requires Contractor to achieve by an intermediate completion date, or by a time prior to Substantial Completion of all the Work.
28. *Notice of Award*—The written notice by Owner to a Bidder of Owner's acceptance of the Bid.
29. *Notice to Proceed*—A written notice by Owner to Contractor fixing the date on which the Contract Times will commence to run and on which Contractor shall start to perform the Work.
30. *Owner*—The individual or entity with which Contractor has contracted regarding the Work, and which has agreed to pay Contractor for the performance of the Work, pursuant to the terms of the Contract.
31. *Progress Schedule*—A schedule, prepared and maintained by Contractor, describing the sequence and duration of the activities comprising Contractor's plan to accomplish the Work within the Contract Times.
32. *Project*—The total undertaking to be accomplished for Owner by engineers, contractors, and others, including planning, study, design, construction, testing, commissioning, and start-up, and of which the Work to be performed under the Contract Documents is a part.

33. *Resident Project Representative*—The authorized representative of Engineer assigned to assist Engineer at the Site. As used herein, the term Resident Project Representative (RPR) includes any assistants or field staff of Resident Project Representative.
34. *Samples*—Physical examples of materials, equipment, or workmanship that are representative of some portion of the Work and that establish the standards by which such portion of the Work will be judged.
35. *Schedule of Submittals*—A schedule, prepared and maintained by Contractor, of required submittals and the time requirements for Engineer’s review of the submittals.
36. *Schedule of Values*—A schedule, prepared and maintained by Contractor, allocating portions of the Contract Price to various portions of the Work and used as the basis for reviewing Contractor’s Applications for Payment.
37. *Shop Drawings*—All drawings, diagrams, illustrations, schedules, and other data or information that are specifically prepared or assembled by or for Contractor and submitted by Contractor to illustrate some portion of the Work. Shop Drawings, whether approved or not, are not Drawings and are not Contract Documents.
38. *Site*—Lands or areas indicated in the Contract Documents as being furnished by Owner upon which the Work is to be performed, including rights-of-way and easements, and such other lands or areas furnished by Owner which are designated for the use of Contractor.
39. *Specifications*—The part of the Contract that consists of written requirements for materials, equipment, systems, standards, and workmanship as applied to the Work, and certain administrative requirements and procedural matters applicable to the Work.
40. *Subcontractor*—An individual or entity having a direct contract with Contractor or with any other Subcontractor for the performance of a part of the Work.
41. *Submittal*—A written or graphic document, prepared by or for Contractor, which the Contract Documents require Contractor to submit to Engineer, or that is indicated as a Submittal in the Schedule of Submittals accepted by Engineer. Submittals may include Shop Drawings and Samples; schedules; product data; Owner-delegated designs; sustainable design information; information on special procedures; testing plans; results of tests and evaluations, source quality-control testing and inspections, and field or Site quality-control testing and inspections; warranties and certifications; Suppliers’ instructions and reports; records of delivery of spare parts and tools; operations and maintenance data; Project photographic documentation; record documents; and other such documents required by the Contract Documents. Submittals, whether or not approved or accepted by Engineer, are not Contract Documents. Change Proposals, Change Orders, Claims, notices, Applications for Payment, and requests for interpretation or clarification are not Submittals.
42. *Substantial Completion*—The time at which the Work (or a specified part thereof) has progressed to the point where, in the opinion of Engineer, the Work (or a specified part thereof) is sufficiently complete, in accordance with the Contract Documents, so that the Work (or a specified part thereof) can be utilized for the purposes for which it is intended. The terms “substantially complete” and “substantially completed” as applied to all or part of the Work refer to Substantial Completion of such Work.

43. *Successful Bidder*—The Bidder to which the Owner makes an award of contract.
44. *Supplementary Conditions*—The part of the Contract that amends or supplements these General Conditions.
45. *Supplier*—A manufacturer, fabricator, supplier, distributor, or vendor having a direct contract with Contractor or with any Subcontractor to furnish materials or equipment to be incorporated in the Work by Contractor or a Subcontractor.
46. *Technical Data*
- a. Those items expressly identified as Technical Data in the Supplementary Conditions, with respect to either (1) existing subsurface conditions at or adjacent to the Site, or existing physical conditions at or adjacent to the Site including existing surface or subsurface structures (except Underground Facilities) or (2) Hazardous Environmental Conditions at the Site.
 - b. If no such express identifications of Technical Data have been made with respect to conditions at the Site, then Technical Data is defined, with respect to conditions at the Site under Paragraphs 5.03, 5.04, and 5.06, as the data contained in boring logs, recorded measurements of subsurface water levels, assessments of the condition of subsurface facilities, laboratory test results, and other factual, objective information regarding conditions at the Site that are set forth in any geotechnical, environmental, or other Site or facilities conditions report prepared for the Project and made available to Contractor.
 - c. Information and data regarding the presence or location of Underground Facilities are not intended to be categorized, identified, or defined as Technical Data, and instead Underground Facilities are shown or indicated on the Drawings.
47. *Underground Facilities*—All active or not-in-service underground lines, pipelines, conduits, ducts, encasements, cables, wires, manholes, vaults, tanks, tunnels, or other such facilities or systems at the Site, including but not limited to those facilities or systems that produce, transmit, distribute, or convey telephone or other communications, cable television, fiber optic transmissions, power, electricity, light, heat, gases, oil, crude oil products, liquid petroleum products, water, steam, waste, wastewater, storm water, other liquids or chemicals, or traffic or other control systems. An abandoned facility or system is not an Underground Facility.
48. *Unit Price Work*—Work to be paid for on the basis of unit prices.
49. *Work*—The entire construction or the various separately identifiable parts thereof required to be provided under the Contract Documents. Work includes and is the result of performing or providing all labor, services, and documentation necessary to produce such construction; furnishing, installing, and incorporating all materials and equipment into such construction; and may include related services such as testing, start-up, and commissioning, all as required by the Contract Documents.
50. *Work Change Directive*—A written directive to Contractor issued on or after the Effective Date of the Contract, signed by Owner and recommended by Engineer, ordering an addition, deletion, or revision in the Work.

1.02 Terminology

- A. The words and terms discussed in Paragraphs 1.02.B, C, D, and E are not defined terms that require initial capital letters, but, when used in the Bidding Requirements or Contract Documents, have the indicated meaning.
- B. *Intent of Certain Terms or Adjectives:* The Contract Documents include the terms “as allowed,” “as approved,” “as ordered,” “as directed” or terms of like effect or import to authorize an exercise of professional judgment by Engineer. In addition, the adjectives “reasonable,” “suitable,” “acceptable,” “proper,” “satisfactory,” or adjectives of like effect or import are used to describe an action or determination of Engineer as to the Work. It is intended that such exercise of professional judgment, action, or determination will be solely to evaluate, in general, the Work for compliance with the information in the Contract Documents and with the design concept of the Project as a functioning whole as shown or indicated in the Contract Documents (unless there is a specific statement indicating otherwise). The use of any such term or adjective is not intended to and shall not be effective to assign to Engineer any duty or authority to supervise or direct the performance of the Work, or any duty or authority to undertake responsibility contrary to the provisions of Article 10 or any other provision of the Contract Documents.
- C. *Day:* The word “day” means a calendar day of 24 hours measured from midnight to the next midnight.
- D. *Defective:* The word “defective,” when modifying the word “Work,” refers to Work that is unsatisfactory, faulty, or deficient in that it:
 - 1. does not conform to the Contract Documents;
 - 2. does not meet the requirements of any applicable inspection, reference standard, test, or approval referred to in the Contract Documents; or
 - 3. has been damaged prior to Engineer’s recommendation of final payment (unless responsibility for the protection thereof has been assumed by Owner at Substantial Completion in accordance with Paragraph 15.03 or Paragraph 15.04).
- E. *Furnish, Install, Perform, Provide*
 - 1. The word “furnish,” when used in connection with services, materials, or equipment, means to supply and deliver said services, materials, or equipment to the Site (or some other specified location) ready for use or installation and in usable or operable condition.
 - 2. The word “install,” when used in connection with services, materials, or equipment, means to put into use or place in final position said services, materials, or equipment complete and ready for intended use.
 - 3. The words “perform” or “provide,” when used in connection with services, materials, or equipment, means to furnish and install said services, materials, or equipment complete and ready for intended use.
 - 4. If the Contract Documents establish an obligation of Contractor with respect to specific services, materials, or equipment, but do not expressly use any of the four words “furnish,” “install,” “perform,” or “provide,” then Contractor shall furnish and install said services, materials, or equipment complete and ready for intended use.

- F. *Contract Price or Contract Times*: References to a change in “Contract Price or Contract Times” or “Contract Times or Contract Price” or similar, indicate that such change applies to (1) Contract Price, (2) Contract Times, or (3) both Contract Price and Contract Times, as warranted, even if the term “or both” is not expressed.
- G. Unless stated otherwise in the Contract Documents, words or phrases that have a well-known technical or construction industry or trade meaning are used in the Contract Documents in accordance with such recognized meaning.

ARTICLE 2—PRELIMINARY MATTERS

2.01 *Delivery of Performance and Payment Bonds; Evidence of Insurance*

- A. *Performance and Payment Bonds*: When Contractor delivers the signed counterparts of the Agreement to Owner, Contractor shall also deliver to Owner the performance bond and payment bond (if the Contract requires Contractor to furnish such bonds).
- B. *Evidence of Contractor’s Insurance*: When Contractor delivers the signed counterparts of the Agreement to Owner, Contractor shall also deliver to Owner, with copies to each additional insured (as identified in the Contract), the certificates, endorsements, and other evidence of insurance required to be provided by Contractor in accordance with Article 6, except to the extent the Supplementary Conditions expressly establish other dates for delivery of specific insurance policies.
- C. *Evidence of Owner’s Insurance*: After receipt of the signed counterparts of the Agreement and all required bonds and insurance documentation, Owner shall promptly deliver to Contractor, with copies to each additional insured (as identified in the Contract), the certificates and other evidence of insurance required to be provided by Owner under Article 6.

2.02 *Copies of Documents*

- A. Owner shall furnish to Contractor four printed copies of the Contract (including one fully signed counterpart of the Agreement), and one copy in electronic portable document format (PDF). Additional printed copies will be furnished upon request at the cost of reproduction.
- B. Owner shall maintain and safeguard at least one original printed record version of the Contract, including Drawings and Specifications signed and sealed by Engineer and other design professionals. Owner shall make such original printed record version of the Contract available to Contractor for review. Owner may delegate the responsibilities under this provision to Engineer.

2.03 *Before Starting Construction*

- A. *Preliminary Schedules*: Within 10 days after the Effective Date of the Contract (or as otherwise required by the Contract Documents), Contractor shall submit to Engineer for timely review:
 - 1. a preliminary Progress Schedule indicating the times (numbers of days or dates) for starting and completing the various stages of the Work, including any Milestones specified in the Contract;
 - 2. a preliminary Schedule of Submittals; and
 - 3. a preliminary Schedule of Values for all of the Work which includes quantities and prices of items which when added together equal the Contract Price and subdivides the Work

into component parts in sufficient detail to serve as the basis for progress payments during performance of the Work. Such prices will include an appropriate amount of overhead and profit applicable to each item of Work.

2.04 *Preconstruction Conference; Designation of Authorized Representatives*

- A. Before any Work at the Site is started, a conference attended by Owner, Contractor, Engineer, and others as appropriate will be held to establish a working understanding among the parties as to the Work, and to discuss the schedules referred to in Paragraph 2.03.A, procedures for handling Shop Drawings, Samples, and other Submittals, processing Applications for Payment, electronic or digital transmittals, and maintaining required records.
- B. At this conference Owner and Contractor each shall designate, in writing, a specific individual to act as its authorized representative with respect to the services and responsibilities under the Contract. Such individuals shall have the authority to transmit and receive information, render decisions relative to the Contract, and otherwise act on behalf of each respective party.

2.05 *Acceptance of Schedules*

- A. At least 10 days before submission of the first Application for Payment a conference, attended by Contractor, Engineer, and others as appropriate, will be held to review the schedules submitted in accordance with Paragraph 2.03.A. No progress payment will be made to Contractor until acceptable schedules are submitted to Engineer.
 - 1. The Progress Schedule will be acceptable to Engineer if it provides an orderly progression of the Work to completion within the Contract Times. Such acceptance will not impose on Engineer responsibility for the Progress Schedule, for sequencing, scheduling, or progress of the Work, nor interfere with or relieve Contractor from Contractor's full responsibility therefor.
 - 2. Contractor's Schedule of Submittals will be acceptable to Engineer if it provides a workable arrangement for reviewing and processing the required submittals.
 - 3. Contractor's Schedule of Values will be acceptable to Engineer as to form and substance if it provides a reasonable allocation of the Contract Price to the component parts of the Work.
 - 4. If a schedule is not acceptable, Contractor will have an additional 10 days to revise and resubmit the schedule.

2.06 *Electronic Transmittals*

- A. Except as otherwise stated elsewhere in the Contract, the Owner, Engineer, and Contractor may send, and shall accept, Electronic Documents transmitted by Electronic Means.
- B. If the Contract does not establish protocols for Electronic Means, then Owner, Engineer, and Contractor shall jointly develop such protocols.
- C. Subject to any governing protocols for Electronic Means, when transmitting Electronic Documents by Electronic Means, the transmitting party makes no representations as to long-term compatibility, usability, or readability of the Electronic Documents resulting from the recipient's use of software application packages, operating systems, or computer hardware differing from those used in the drafting or transmittal of the Electronic Documents.

ARTICLE 3—CONTRACT DOCUMENTS: INTENT, REQUIREMENTS, REUSE

3.01 *Intent*

- A. The Contract Documents are complementary; what is required by one Contract Document is as binding as if required by all.
- B. It is the intent of the Contract Documents to describe a functionally complete Project (or part thereof) to be constructed in accordance with the Contract Documents.
- C. Unless otherwise stated in the Contract Documents, if there is a discrepancy between the electronic versions of the Contract Documents (including any printed copies derived from such electronic versions) and the printed record version, the printed record version will govern.
- D. The Contract supersedes prior negotiations, representations, and agreements, whether written or oral.
- E. Engineer will issue clarifications and interpretations of the Contract Documents as provided herein.
- F. Any provision or part of the Contract Documents held to be void or unenforceable under any Law or Regulation will be deemed stricken, and all remaining provisions will continue to be valid and binding upon Owner and Contractor, which agree that the Contract Documents will be reformed to replace such stricken provision or part thereof with a valid and enforceable provision that comes as close as possible to expressing the intention of the stricken provision.
- G. Nothing in the Contract Documents creates:
 - 1. any contractual relationship between Owner or Engineer and any Subcontractor, Supplier, or other individual or entity performing or furnishing any of the Work, for the benefit of such Subcontractor, Supplier, or other individual or entity; or
 - 2. any obligation on the part of Owner or Engineer to pay or to see to the payment of any money due any such Subcontractor, Supplier, or other individual or entity, except as may otherwise be required by Laws and Regulations.

3.02 *Reference Standards*

- A. *Standards Specifications, Codes, Laws and Regulations*
 - 1. Reference in the Contract Documents to standard specifications, manuals, reference standards, or codes of any technical society, organization, or association, or to Laws or Regulations, whether such reference be specific or by implication, means the standard specification, manual, reference standard, code, or Laws or Regulations in effect at the time of opening of Bids (or on the Effective Date of the Contract if there were no Bids), except as may be otherwise specifically stated in the Contract Documents.
 - 2. No provision of any such standard specification, manual, reference standard, or code, and no instruction of a Supplier, will be effective to change the duties or responsibilities of Owner, Contractor, or Engineer from those set forth in the part of the Contract Documents prepared by or for Engineer. No such provision or instruction shall be effective to assign to Owner or Engineer any duty or authority to supervise or direct the performance of the Work, or any duty or authority to undertake responsibility

inconsistent with the provisions of the part of the Contract Documents prepared by or for Engineer.

3.03 *Reporting and Resolving Discrepancies*

A. *Reporting Discrepancies*

1. *Contractor's Verification of Figures and Field Measurements:* Before undertaking each part of the Work, Contractor shall carefully study the Contract Documents, and check and verify pertinent figures and dimensions therein, particularly with respect to applicable field measurements. Contractor shall promptly report in writing to Engineer any conflict, error, ambiguity, or discrepancy that Contractor discovers, or has actual knowledge of, and shall not proceed with any Work affected thereby until the conflict, error, ambiguity, or discrepancy is resolved by a clarification or interpretation by Engineer, or by an amendment or supplement to the Contract issued pursuant to Paragraph 11.01.
2. *Contractor's Review of Contract Documents:* If, before or during the performance of the Work, Contractor discovers any conflict, error, ambiguity, or discrepancy within the Contract Documents, or between the Contract Documents and (a) any applicable Law or Regulation, (b) actual field conditions, (c) any standard specification, manual, reference standard, or code, or (d) any instruction of any Supplier, then Contractor shall promptly report it to Engineer in writing. Contractor shall not proceed with the Work affected thereby (except in an emergency as required by Paragraph 7.15) until the conflict, error, ambiguity, or discrepancy is resolved, by a clarification or interpretation by Engineer, or by an amendment or supplement to the Contract issued pursuant to Paragraph 11.01.
3. Contractor shall not be liable to Owner or Engineer for failure to report any conflict, error, ambiguity, or discrepancy in the Contract Documents unless Contractor had actual knowledge thereof.

B. *Resolving Discrepancies*

1. Except as may be otherwise specifically stated in the Contract Documents, the provisions of the part of the Contract Documents prepared by or for Engineer take precedence in resolving any conflict, error, ambiguity, or discrepancy between such provisions of the Contract Documents and:
 - a. the provisions of any standard specification, manual, reference standard, or code, or the instruction of any Supplier (whether or not specifically incorporated by reference as a Contract Document); or
 - b. the provisions of any Laws or Regulations applicable to the performance of the Work (unless such an interpretation of the provisions of the Contract Documents would result in violation of such Law or Regulation).

3.04 *Requirements of the Contract Documents*

- A. During the performance of the Work and until final payment, Contractor and Owner shall submit to the Engineer in writing all matters in question concerning the requirements of the Contract Documents (sometimes referred to as requests for information or interpretation—RFIs), or relating to the acceptability of the Work under the Contract Documents, as soon as possible after such matters arise. Engineer will be the initial interpreter of the requirements of the Contract Documents, and judge of the acceptability of the Work.

- B. Engineer will, with reasonable promptness, render a written clarification, interpretation, or decision on the issue submitted, or initiate an amendment or supplement to the Contract Documents. Engineer's written clarification, interpretation, or decision will be final and binding on Contractor, unless it appeals by submitting a Change Proposal, and on Owner, unless it appeals by filing a Claim.
- C. If a submitted matter in question concerns terms and conditions of the Contract Documents that do not involve (1) the performance or acceptability of the Work under the Contract Documents, (2) the design (as set forth in the Drawings, Specifications, or otherwise), or (3) other engineering or technical matters, then Engineer will promptly notify Owner and Contractor in writing that Engineer is unable to provide a decision or interpretation. If Owner and Contractor are unable to agree on resolution of such a matter in question, either party may pursue resolution as provided in Article 12.

3.05 *Reuse of Documents*

- A. Contractor and its Subcontractors and Suppliers shall not:
 - 1. have or acquire any title to or ownership rights in any of the Drawings, Specifications, or other documents (or copies of any thereof) prepared by or bearing the seal of Engineer or its consultants, including electronic media versions, or reuse any such Drawings, Specifications, other documents, or copies thereof on extensions of the Project or any other project without written consent of Owner and Engineer and specific written verification or adaptation by Engineer; or
 - 2. have or acquire any title or ownership rights in any other Contract Documents, reuse any such Contract Documents for any purpose without Owner's express written consent, or violate any copyrights pertaining to such Contract Documents.
- B. The prohibitions of this Paragraph 3.05 will survive final payment, or termination of the Contract. Nothing herein precludes Contractor from retaining copies of the Contract Documents for record purposes.

ARTICLE 4—COMMENCEMENT AND PROGRESS OF THE WORK

4.01 *Commencement of Contract Times; Notice to Proceed*

- A. The Contract Times will commence to run on the 30th day after the Effective Date of the Contract or, if a Notice to Proceed is given, on the day indicated in the Notice to Proceed. A Notice to Proceed may be given at any time within 30 days after the Effective Date of the Contract. In no event will the Contract Times commence to run later than the 60th day after the day of Bid opening or the 30th day after the Effective Date of the Contract, whichever date is earlier.

4.02 *Starting the Work*

- A. Contractor shall start to perform the Work on the date when the Contract Times commence to run. No Work may be done at the Site prior to such date.

4.03 *Reference Points*

- A. Owner shall provide engineering surveys to establish reference points for construction which in Engineer's judgment are necessary to enable Contractor to proceed with the Work. Contractor shall be responsible for laying out the Work, shall protect and preserve the

established reference points and property monuments, and shall make no changes or relocations without the prior written approval of Owner. Contractor shall report to Engineer whenever any reference point or property monument is lost or destroyed or requires relocation because of necessary changes in grades or locations, and shall be responsible for the accurate replacement or relocation of such reference points or property monuments by professionally qualified personnel.

4.04 *Progress Schedule*

- A. Contractor shall adhere to the Progress Schedule established in accordance with Paragraph 2.05 as it may be adjusted from time to time as provided below.
 - 1. Contractor shall submit to Engineer for acceptance (to the extent indicated in Paragraph 2.05) proposed adjustments in the Progress Schedule that will not result in changing the Contract Times.
 - 2. Proposed adjustments in the Progress Schedule that will change the Contract Times must be submitted in accordance with the requirements of Article 11.
- B. Contractor shall carry on the Work and adhere to the Progress Schedule during all disputes or disagreements with Owner. No Work will be delayed or postponed pending resolution of any disputes or disagreements, or during any appeal process, except as permitted by Paragraph 16.04, or as Owner and Contractor may otherwise agree in writing.

4.05 *Delays in Contractor's Progress*

- A. If Owner, Engineer, or anyone for whom Owner is responsible, delays, disrupts, or interferes with the performance or progress of the Work, then Contractor shall be entitled to an equitable adjustment in Contract Price or Contract Times.
- B. Contractor shall not be entitled to an adjustment in Contract Price or Contract Times for delay, disruption, or interference caused by or within the control of Contractor. Delay, disruption, and interference attributable to and within the control of a Subcontractor or Supplier shall be deemed to be within the control of Contractor.
- C. If Contractor's performance or progress is delayed, disrupted, or interfered with by unanticipated causes not the fault of and beyond the control of Owner, Contractor, and those for which they are responsible, then Contractor shall be entitled to an equitable adjustment in Contract Times. Such an adjustment will be Contractor's sole and exclusive remedy for the delays, disruption, and interference described in this paragraph. Causes of delay, disruption, or interference that may give rise to an adjustment in Contract Times under this paragraph include but are not limited to the following:
 - 1. Severe and unavoidable natural catastrophes such as fires, floods, epidemics, and earthquakes;
 - 2. Abnormal weather conditions;
 - 3. Acts or failures to act of third-party utility owners or other third-party entities (other than those third-party utility owners or other third-party entities performing other work at or adjacent to the Site as arranged by or under contract with Owner, as contemplated in Article 8); and
 - 4. Acts of war or terrorism.

- D. Contractor's entitlement to an adjustment of Contract Times or Contract Price is limited as follows:
1. Contractor's entitlement to an adjustment of the Contract Times is conditioned on the delay, disruption, or interference adversely affecting an activity on the critical path to completion of the Work, as of the time of the delay, disruption, or interference.
 2. Contractor shall not be entitled to an adjustment in Contract Price for any delay, disruption, or interference if such delay is concurrent with a delay, disruption, or interference caused by or within the control of Contractor. Such a concurrent delay by Contractor shall not preclude an adjustment of Contract Times to which Contractor is otherwise entitled.
 3. Adjustments of Contract Times or Contract Price are subject to the provisions of Article 11.
- E. Each Contractor request or Change Proposal seeking an increase in Contract Times or Contract Price must be supplemented by supporting data that sets forth in detail the following:
1. The circumstances that form the basis for the requested adjustment;
 2. The date upon which each cause of delay, disruption, or interference began to affect the progress of the Work;
 3. The date upon which each cause of delay, disruption, or interference ceased to affect the progress of the Work;
 4. The number of days' increase in Contract Times claimed as a consequence of each such cause of delay, disruption, or interference; and
 5. The impact on Contract Price, in accordance with the provisions of Paragraph 11.07.
- Contractor shall also furnish such additional supporting documentation as Owner or Engineer may require including, where appropriate, a revised progress schedule indicating all the activities affected by the delay, disruption, or interference, and an explanation of the effect of the delay, disruption, or interference on the critical path to completion of the Work.
- F. Delays, disruption, and interference to the performance or progress of the Work resulting from the existence of a differing subsurface or physical condition, an Underground Facility that was not shown or indicated by the Contract Documents, or not shown or indicated with reasonable accuracy, and those resulting from Hazardous Environmental Conditions, are governed by Article 5, together with the provisions of Paragraphs 4.05.D and 4.05.E.
- G. Paragraph 8.03 addresses delays, disruption, and interference to the performance or progress of the Work resulting from the performance of certain other work at or adjacent to the Site.

ARTICLE 5—SITE; SUBSURFACE AND PHYSICAL CONDITIONS; HAZARDOUS ENVIRONMENTAL CONDITIONS

5.01 *Availability of Lands*

- A. Owner shall furnish the Site. Owner shall notify Contractor in writing of any encumbrances or restrictions not of general application but specifically related to use of the Site with which Contractor must comply in performing the Work.

- B. Upon reasonable written request, Owner shall furnish Contractor with a current statement of record legal title and legal description of the lands upon which permanent improvements are to be made and Owner's interest therein as necessary for giving notice of or filing a mechanic's or construction lien against such lands in accordance with applicable Laws and Regulations.
- C. Contractor shall provide for all additional lands and access thereto that may be required for temporary construction facilities or storage of materials and equipment.

5.02 *Use of Site and Other Areas*

A. *Limitation on Use of Site and Other Areas*

1. Contractor shall confine construction equipment, temporary construction facilities, the storage of materials and equipment, and the operations of workers to the Site, adjacent areas that Contractor has arranged to use through construction easements or otherwise, and other adjacent areas permitted by Laws and Regulations, and shall not unreasonably encumber the Site and such other adjacent areas with construction equipment or other materials or equipment. Contractor shall assume full responsibility for (a) damage to the Site; (b) damage to any such other adjacent areas used for Contractor's operations; (c) damage to any other adjacent land or areas, or to improvements, structures, utilities, or similar facilities located at such adjacent lands or areas; and (d) for injuries and losses sustained by the owners or occupants of any such land or areas; provided that such damage or injuries result from the performance of the Work or from other actions or conduct of the Contractor or those for which Contractor is responsible.
 2. If a damage or injury claim is made by the owner or occupant of any such land or area because of the performance of the Work, or because of other actions or conduct of the Contractor or those for which Contractor is responsible, Contractor shall (a) take immediate corrective or remedial action as required by Paragraph 7.13, or otherwise; (b) promptly attempt to settle the claim as to all parties through negotiations with such owner or occupant, or otherwise resolve the claim by arbitration or other dispute resolution proceeding, or in a court of competent jurisdiction; and (c) to the fullest extent permitted by Laws and Regulations, indemnify and hold harmless Owner and Engineer, and the officers, directors, members, partners, employees, agents, consultants and subcontractors of each and any of them, from and against any such claim, and against all costs, losses, and damages (including but not limited to all fees and charges of engineers, architects, attorneys, and other professionals and all court or arbitration or other dispute resolution costs) arising out of or relating to any claim or action, legal or equitable, brought by any such owner or occupant against Owner, Engineer, or any other party indemnified hereunder to the extent caused directly or indirectly, in whole or in part by, or based upon, Contractor's performance of the Work, or because of other actions or conduct of the Contractor or those for which Contractor is responsible.
- B. *Removal of Debris During Performance of the Work:* During the progress of the Work the Contractor shall keep the Site and other adjacent areas free from accumulations of waste materials, rubbish, and other debris. Removal and disposal of such waste materials, rubbish, and other debris will conform to applicable Laws and Regulations.
 - C. *Cleaning:* Prior to Substantial Completion of the Work Contractor shall clean the Site and the Work and make it ready for utilization by Owner. At the completion of the Work Contractor shall remove from the Site and adjacent areas all tools, appliances, construction equipment

and machinery, and surplus materials and shall restore to original condition all property not designated for alteration by the Contract Documents.

- D. *Loading of Structures*: Contractor shall not load nor permit any part of any structure to be loaded in any manner that will endanger the structure, nor shall Contractor subject any part of the Work or adjacent structures or land to stresses or pressures that will endanger them.

5.03 *Subsurface and Physical Conditions*

- A. *Reports and Drawings*: The Supplementary Conditions identify:

1. Those reports of explorations and tests of subsurface conditions at or adjacent to the Site that contain Technical Data;
2. Those drawings of existing physical conditions at or adjacent to the Site, including those drawings depicting existing surface or subsurface structures at or adjacent to the Site (except Underground Facilities), that contain Technical Data; and
3. Technical Data contained in such reports and drawings.

- B. *Underground Facilities*: Underground Facilities are shown or indicated on the Drawings, pursuant to Paragraph 5.05, and not in the drawings referred to in Paragraph 5.03.A. Information and data regarding the presence or location of Underground Facilities are not intended to be categorized, identified, or defined as Technical Data.

- C. *Reliance by Contractor on Technical Data*: Contractor may rely upon the accuracy of the Technical Data expressly identified in the Supplementary Conditions with respect to such reports and drawings, but such reports and drawings are not Contract Documents. If no such express identification has been made, then Contractor may rely upon the accuracy of the Technical Data as defined in Paragraph 1.01.A.46.b.

- D. *Limitations of Other Data and Documents*: Except for such reliance on Technical Data, Contractor may not rely upon or make any claim against Owner or Engineer, or any of their officers, directors, members, partners, employees, agents, consultants, or subcontractors, with respect to:

1. the completeness of such reports and drawings for Contractor's purposes, including, but not limited to, any aspects of the means, methods, techniques, sequences, and procedures of construction to be employed by Contractor, and safety precautions and programs incident thereto;
2. other data, interpretations, opinions, and information contained in such reports or shown or indicated in such drawings;
3. the contents of other Site-related documents made available to Contractor, such as record drawings from other projects at or adjacent to the Site, or Owner's archival documents concerning the Site; or
4. any Contractor interpretation of or conclusion drawn from any Technical Data or any such other data, interpretations, opinions, or information.

5.04 *Differing Subsurface or Physical Conditions*

- A. *Notice by Contractor:* If Contractor believes that any subsurface or physical condition that is uncovered or revealed at the Site:
1. is of such a nature as to establish that any Technical Data on which Contractor is entitled to rely as provided in Paragraph 5.03 is materially inaccurate;
 2. is of such a nature as to require a change in the Drawings or Specifications;
 3. differs materially from that shown or indicated in the Contract Documents; or
 4. is of an unusual nature, and differs materially from conditions ordinarily encountered and generally recognized as inherent in work of the character provided for in the Contract Documents;

then Contractor shall, promptly after becoming aware thereof and before further disturbing the subsurface or physical conditions or performing any Work in connection therewith (except in an emergency as required by Paragraph 7.15), notify Owner and Engineer in writing about such condition. Contractor shall not further disturb such condition or perform any Work in connection therewith (except with respect to an emergency) until receipt of a written statement permitting Contractor to do so.

- B. *Engineer's Review:* After receipt of written notice as required by the preceding paragraph, Engineer will promptly review the subsurface or physical condition in question; determine whether it is necessary for Owner to obtain additional exploration or tests with respect to the condition; conclude whether the condition falls within any one or more of the differing site condition categories in Paragraph 5.04.A; obtain any pertinent cost or schedule information from Contractor; prepare recommendations to Owner regarding the Contractor's resumption of Work in connection with the subsurface or physical condition in question and the need for any change in the Drawings or Specifications; and advise Owner in writing of Engineer's findings, conclusions, and recommendations.
- C. *Owner's Statement to Contractor Regarding Site Condition:* After receipt of Engineer's written findings, conclusions, and recommendations, Owner shall issue a written statement to Contractor (with a copy to Engineer) regarding the subsurface or physical condition in question, addressing the resumption of Work in connection with such condition, indicating whether any change in the Drawings or Specifications will be made, and adopting or rejecting Engineer's written findings, conclusions, and recommendations, in whole or in part.
- D. *Early Resumption of Work:* If at any time Engineer determines that Work in connection with the subsurface or physical condition in question may resume prior to completion of Engineer's review or Owner's issuance of its statement to Contractor, because the condition in question has been adequately documented, and analyzed on a preliminary basis, then the Engineer may at its discretion instruct Contractor to resume such Work.
- E. *Possible Price and Times Adjustments*
1. Contractor shall be entitled to an equitable adjustment in Contract Price or Contract Times, to the extent that the existence of a differing subsurface or physical condition, or any related delay, disruption, or interference, causes an increase or decrease in

Contractor's cost of, or time required for, performance of the Work; subject, however, to the following:

- a. Such condition must fall within any one or more of the categories described in Paragraph 5.04.A;
 - b. With respect to Work that is paid for on a unit price basis, any adjustment in Contract Price will be subject to the provisions of Paragraph 13.03; and,
 - c. Contractor's entitlement to an adjustment of the Contract Times is subject to the provisions of Paragraphs 4.05.D and 4.05.E.
2. Contractor shall not be entitled to any adjustment in the Contract Price or Contract Times with respect to a subsurface or physical condition if:
- a. Contractor knew of the existence of such condition at the time Contractor made a commitment to Owner with respect to Contract Price and Contract Times by the submission of a Bid or becoming bound under a negotiated contract, or otherwise;
 - b. The existence of such condition reasonably could have been discovered or revealed as a result of any examination, investigation, exploration, test, or study of the Site and contiguous areas expressly required by the Bidding Requirements or Contract Documents to be conducted by or for Contractor prior to Contractor's making such commitment; or
 - c. Contractor failed to give the written notice required by Paragraph 5.04.A.
3. If Owner and Contractor agree regarding Contractor's entitlement to and the amount or extent of any adjustment in the Contract Price or Contract Times, then any such adjustment will be set forth in a Change Order.
4. Contractor may submit a Change Proposal regarding its entitlement to or the amount or extent of any adjustment in the Contract Price or Contract Times, no later than 30 days after Owner's issuance of the Owner's written statement to Contractor regarding the subsurface or physical condition in question.
- F. *Underground Facilities; Hazardous Environmental Conditions*: Paragraph 5.05 governs rights and responsibilities regarding the presence or location of Underground Facilities. Paragraph 5.06 governs rights and responsibilities regarding Hazardous Environmental Conditions. The provisions of Paragraphs 5.03 and 5.04 are not applicable to the presence or location of Underground Facilities, or to Hazardous Environmental Conditions.

5.05 *Underground Facilities*

- A. *Contractor's Responsibilities*: Unless it is otherwise expressly provided in the Supplementary Conditions, the cost of all of the following are included in the Contract Price, and Contractor shall have full responsibility for:
1. reviewing and checking all information and data regarding existing Underground Facilities at the Site;
 2. complying with applicable state and local utility damage prevention Laws and Regulations;

3. verifying the actual location of those Underground Facilities shown or indicated in the Contract Documents as being within the area affected by the Work, by exposing such Underground Facilities during the course of construction;
 4. coordination of the Work with the owners (including Owner) of such Underground Facilities, during construction; and
 5. the safety and protection of all existing Underground Facilities at the Site, and repairing any damage thereto resulting from the Work.
- B. *Notice by Contractor:* If Contractor believes that an Underground Facility that is uncovered or revealed at the Site was not shown or indicated on the Drawings, or was not shown or indicated on the Drawings with reasonable accuracy, then Contractor shall, promptly after becoming aware thereof and before further disturbing conditions affected thereby or performing any Work in connection therewith (except in an emergency as required by Paragraph 7.15), notify Owner and Engineer in writing regarding such Underground Facility.
- C. *Engineer's Review:* Engineer will:
1. promptly review the Underground Facility and conclude whether such Underground Facility was not shown or indicated on the Drawings, or was not shown or indicated with reasonable accuracy;
 2. identify and communicate with the owner of the Underground Facility; prepare recommendations to Owner (and if necessary issue any preliminary instructions to Contractor) regarding the Contractor's resumption of Work in connection with the Underground Facility in question;
 3. obtain any pertinent cost or schedule information from Contractor; determine the extent, if any, to which a change is required in the Drawings or Specifications to reflect and document the consequences of the existence or location of the Underground Facility; and
 4. advise Owner in writing of Engineer's findings, conclusions, and recommendations.

During such time, Contractor shall be responsible for the safety and protection of such Underground Facility.

- D. *Owner's Statement to Contractor Regarding Underground Facility:* After receipt of Engineer's written findings, conclusions, and recommendations, Owner shall issue a written statement to Contractor (with a copy to Engineer) regarding the Underground Facility in question addressing the resumption of Work in connection with such Underground Facility, indicating whether any change in the Drawings or Specifications will be made, and adopting or rejecting Engineer's written findings, conclusions, and recommendations in whole or in part.
- E. *Early Resumption of Work:* If at any time Engineer determines that Work in connection with the Underground Facility may resume prior to completion of Engineer's review or Owner's issuance of its statement to Contractor, because the Underground Facility in question and conditions affected by its presence have been adequately documented, and analyzed on a preliminary basis, then the Engineer may at its discretion instruct Contractor to resume such Work.
- F. *Possible Price and Times Adjustments*
1. Contractor shall be entitled to an equitable adjustment in the Contract Price or Contract Times, to the extent that any existing Underground Facility at the Site that was not shown

or indicated on the Drawings, or was not shown or indicated with reasonable accuracy, or any related delay, disruption, or interference, causes an increase or decrease in Contractor's cost of, or time required for, performance of the Work; subject, however, to the following:

- a. With respect to Work that is paid for on a unit price basis, any adjustment in Contract Price will be subject to the provisions of Paragraph 13.03;
 - b. Contractor's entitlement to an adjustment of the Contract Times is subject to the provisions of Paragraphs 4.05.D and 4.05.E; and
 - c. Contractor gave the notice required in Paragraph 5.05.B.
2. If Owner and Contractor agree regarding Contractor's entitlement to and the amount or extent of any adjustment in the Contract Price or Contract Times, then any such adjustment will be set forth in a Change Order.
 3. Contractor may submit a Change Proposal regarding its entitlement to or the amount or extent of any adjustment in the Contract Price or Contract Times, no later than 30 days after Owner's issuance of the Owner's written statement to Contractor regarding the Underground Facility in question.
 4. The information and data shown or indicated on the Drawings with respect to existing Underground Facilities at the Site is based on information and data (a) furnished by the owners of such Underground Facilities, or by others, (b) obtained from available records, or (c) gathered in an investigation conducted in accordance with the current edition of ASCE 38, Standard Guideline for the Collection and Depiction of Existing Subsurface Utility Data, by the American Society of Civil Engineers. If such information or data is incorrect or incomplete, Contractor's remedies are limited to those set forth in this Paragraph 5.05.F.

5.06 *Hazardous Environmental Conditions at Site*

A. *Reports and Drawings*: The Supplementary Conditions identify:

1. those reports known to Owner relating to Hazardous Environmental Conditions that have been identified at or adjacent to the Site;
2. drawings known to Owner relating to Hazardous Environmental Conditions that have been identified at or adjacent to the Site; and
3. Technical Data contained in such reports and drawings.

B. *Reliance by Contractor on Technical Data Authorized*: Contractor may rely upon the accuracy of the Technical Data expressly identified in the Supplementary Conditions with respect to such reports and drawings, but such reports and drawings are not Contract Documents. If no such express identification has been made, then Contractor may rely on the accuracy of the Technical Data as defined in Paragraph 1.01.A.46.b. Except for such reliance on Technical Data, Contractor may not rely upon or make any claim against Owner or Engineer, or any of their officers, directors, members, partners, employees, agents, consultants, or subcontractors, with respect to:

1. the completeness of such reports and drawings for Contractor's purposes, including, but not limited to, any aspects of the means, methods, techniques, sequences and procedures

- of construction to be employed by Contractor, and safety precautions and programs incident thereto;
2. other data, interpretations, opinions, and information contained in such reports or shown or indicated in such drawings; or
 3. any Contractor interpretation of or conclusion drawn from any Technical Data or any such other data, interpretations, opinions or information.
- C. Contractor shall not be responsible for removing or remediating any Hazardous Environmental Condition encountered, uncovered, or revealed at the Site unless such removal or remediation is expressly identified in the Contract Documents to be within the scope of the Work.
- D. Contractor shall be responsible for controlling, containing, and duly removing all Constituents of Concern brought to the Site by Contractor, Subcontractors, Suppliers, or anyone else for whom Contractor is responsible, and for any associated costs; and for the costs of removing and remediating any Hazardous Environmental Condition created by the presence of any such Constituents of Concern.
- E. If Contractor encounters, uncovers, or reveals a Hazardous Environmental Condition whose removal or remediation is not expressly identified in the Contract Documents as being within the scope of the Work, or if Contractor or anyone for whom Contractor is responsible creates a Hazardous Environmental Condition, then Contractor shall immediately: (1) secure or otherwise isolate such condition; (2) stop all Work in connection with such condition and in any area affected thereby (except in an emergency as required by Paragraph 7.15); and (3) notify Owner and Engineer (and promptly thereafter confirm such notice in writing). Owner shall promptly consult with Engineer concerning the necessity for Owner to retain a qualified expert to evaluate such condition or take corrective action, if any. Promptly after consulting with Engineer, Owner shall take such actions as are necessary to permit Owner to timely obtain required permits and provide Contractor the written notice required by Paragraph 5.06.F. If Contractor or anyone for whom Contractor is responsible created the Hazardous Environmental Condition in question, then Owner may remove and remediate the Hazardous Environmental Condition, and impose a set-off against payments to account for the associated costs.
- F. Contractor shall not resume Work in connection with such Hazardous Environmental Condition or in any affected area until after Owner has obtained any required permits related thereto, and delivered written notice to Contractor either (1) specifying that such condition and any affected area is or has been rendered safe for the resumption of Work, or (2) specifying any special conditions under which such Work may be resumed safely.
- G. If Owner and Contractor cannot agree as to entitlement to or on the amount or extent, if any, of any adjustment in Contract Price or Contract Times, as a result of such Work stoppage, such special conditions under which Work is agreed to be resumed by Contractor, or any costs or expenses incurred in response to the Hazardous Environmental Condition, then within 30 days of Owner's written notice regarding the resumption of Work, Contractor may submit a Change Proposal, or Owner may impose a set-off. Entitlement to any such adjustment is subject to the provisions of Paragraphs 4.05.D, 4.05.E, 11.07, and 11.08.
- H. If, after receipt of such written notice, Contractor does not agree to resume such Work based on a reasonable belief it is unsafe, or does not agree to resume such Work under such special

conditions, then Owner may order the portion of the Work that is in the area affected by such condition to be deleted from the Work, following the contractual change procedures in Article 11. Owner may have such deleted portion of the Work performed by Owner's own forces or others in accordance with Article 8.

- I. To the fullest extent permitted by Laws and Regulations, Owner shall indemnify and hold harmless Contractor, Subcontractors, and Engineer, and the officers, directors, members, partners, employees, agents, consultants, and subcontractors of each and any of them, from and against all claims, costs, losses, and damages (including but not limited to all fees and charges of engineers, architects, attorneys, and other professionals, and all court, arbitration, or other dispute resolution costs) arising out of or relating to a Hazardous Environmental Condition, provided that such Hazardous Environmental Condition (1) was not shown or indicated in the Drawings, Specifications, or other Contract Documents, identified as Technical Data entitled to limited reliance pursuant to Paragraph 5.06.B, or identified in the Contract Documents to be included within the scope of the Work, and (2) was not created by Contractor or by anyone for whom Contractor is responsible. Nothing in this Paragraph 5.06.I obligates Owner to indemnify any individual or entity from and against the consequences of that individual's or entity's own negligence.
- J. To the fullest extent permitted by Laws and Regulations, Contractor shall indemnify and hold harmless Owner and Engineer, and the officers, directors, members, partners, employees, agents, consultants, and subcontractors of each and any of them, from and against all claims, costs, losses, and damages (including but not limited to all fees and charges of engineers, architects, attorneys, and other professionals and all court or arbitration or other dispute resolution costs) arising out of or relating to the failure to control, contain, or remove a Constituent of Concern brought to the Site by Contractor or by anyone for whom Contractor is responsible, or to a Hazardous Environmental Condition created by Contractor or by anyone for whom Contractor is responsible. Nothing in this Paragraph 5.06.J obligates Contractor to indemnify any individual or entity from and against the consequences of that individual's or entity's own negligence.
- K. The provisions of Paragraphs 5.03, 5.04, and 5.05 do not apply to the presence of Constituents of Concern or to a Hazardous Environmental Condition uncovered or revealed at the Site.

ARTICLE 6—BONDS AND INSURANCE

6.01 *Performance, Payment, and Other Bonds*

- A. Contractor shall furnish a performance bond and a payment bond, each in an amount at least equal to the Contract Price, as security for the faithful performance and payment of Contractor's obligations under the Contract. These bonds must remain in effect until one year after the date when final payment becomes due or until completion of the correction period specified in Paragraph 15.08, whichever is later, except as provided otherwise by Laws or Regulations, the terms of a prescribed bond form, the Supplementary Conditions, or other provisions of the Contract.
- B. Contractor shall also furnish such other bonds (if any) as are required by the Supplementary Conditions or other provisions of the Contract.
- C. All bonds must be in the form included in the Bidding Documents or otherwise specified by Owner prior to execution of the Contract, except as provided otherwise by Laws or

Regulations, and must be issued and signed by a surety named in “Companies Holding Certificates of Authority as Acceptable Sureties on Federal Bonds and as Acceptable Reinsuring Companies” as published in Department Circular 570 (as amended and supplemented) by the Bureau of the Fiscal Service, U.S. Department of the Treasury. A bond signed by an agent or attorney-in-fact must be accompanied by a certified copy of that individual’s authority to bind the surety. The evidence of authority must show that it is effective on the date the agent or attorney-in-fact signed the accompanying bond.

- D. Contractor shall obtain the required bonds from surety companies that are duly licensed or authorized, in the state or jurisdiction in which the Project is located, to issue bonds in the required amounts.
- E. If the surety on a bond furnished by Contractor is declared bankrupt or becomes insolvent, or the surety ceases to meet the requirements above, then Contractor shall promptly notify Owner and Engineer in writing and shall, within 20 days after the event giving rise to such notification, provide another bond and surety, both of which must comply with the bond and surety requirements above.
- F. If Contractor has failed to obtain a required bond, Owner may exclude the Contractor from the Site and exercise Owner’s termination rights under Article 16.
- G. Upon request to Owner from any Subcontractor, Supplier, or other person or entity claiming to have furnished labor, services, materials, or equipment used in the performance of the Work, Owner shall provide a copy of the payment bond to such person or entity.
- H. Upon request to Contractor from any Subcontractor, Supplier, or other person or entity claiming to have furnished labor, services, materials, or equipment used in the performance of the Work, Contractor shall provide a copy of the payment bond to such person or entity.

6.02 *Insurance—General Provisions*

- A. Owner and Contractor shall obtain and maintain insurance as required in this article and in the Supplementary Conditions.
- B. All insurance required by the Contract to be purchased and maintained by Owner or Contractor shall be obtained from insurance companies that are duly licensed or authorized in the state or jurisdiction in which the Project is located to issue insurance policies for the required limits and coverages. Unless a different standard is indicated in the Supplementary Conditions, all companies that provide insurance policies required under this Contract shall have an A.M. Best rating of A-VII or better.
- C. Alternative forms of insurance coverage, including but not limited to self-insurance and “Occupational Accident and Excess Employer’s Indemnity Policies,” are not sufficient to meet the insurance requirements of this Contract, unless expressly allowed in the Supplementary Conditions.
- D. Contractor shall deliver to Owner, with copies to each additional insured identified in the Contract, certificates of insurance and endorsements establishing that Contractor has obtained and is maintaining the policies and coverages required by the Contract. Upon request by Owner or any other insured, Contractor shall also furnish other evidence of such required insurance, including but not limited to copies of policies, documentation of applicable self-insured retentions (if allowed) and deductibles, full disclosure of all relevant exclusions, and evidence of insurance required to be purchased and maintained by

Subcontractors or Suppliers. In any documentation furnished under this provision, Contractor, Subcontractors, and Suppliers may block out (redact) (1) any confidential premium or pricing information and (2) any wording specific to a project or jurisdiction other than those applicable to this Contract.

- E. Owner shall deliver to Contractor, with copies to each additional insured identified in the Contract, certificates of insurance and endorsements establishing that Owner has obtained and is maintaining the policies and coverages required of Owner by the Contract (if any). Upon request by Contractor or any other insured, Owner shall also provide other evidence of such required insurance (if any), including but not limited to copies of policies, documentation of applicable self-insured retentions (if allowed) and deductibles, and full disclosure of all relevant exclusions. In any documentation furnished under this provision, Owner may block out (redact) (1) any confidential premium or pricing information and (2) any wording specific to a project or jurisdiction other than those relevant to this Contract.
- F. Failure of Owner or Contractor to demand such certificates or other evidence of the other party's full compliance with these insurance requirements, or failure of Owner or Contractor to identify a deficiency in compliance from the evidence provided, will not be construed as a waiver of the other party's obligation to obtain and maintain such insurance.
- G. In addition to the liability insurance required to be provided by Contractor, the Owner, at Owner's option, may purchase and maintain Owner's own liability insurance. Owner's liability policies, if any, operate separately and independently from policies required to be provided by Contractor, and Contractor cannot rely upon Owner's liability policies for any of Contractor's obligations to the Owner, Engineer, or third parties.
- H. Contractor shall require:
 - 1. Subcontractors to purchase and maintain worker's compensation, commercial general liability, and other insurance that is appropriate for their participation in the Project, and to name as additional insureds Owner and Engineer (and any other individuals or entities identified in the Supplementary Conditions as additional insureds on Contractor's liability policies) on each Subcontractor's commercial general liability insurance policy; and
 - 2. Suppliers to purchase and maintain insurance that is appropriate for their participation in the Project.
- I. If either party does not purchase or maintain the insurance required of such party by the Contract, such party shall notify the other party in writing of such failure to purchase prior to the start of the Work, or of such failure to maintain prior to any change in the required coverage.
- J. If Contractor has failed to obtain and maintain required insurance, Contractor's entitlement to enter or remain at the Site will end immediately, and Owner may impose an appropriate set-off against payment for any associated costs (including but not limited to the cost of purchasing necessary insurance coverage), and exercise Owner's termination rights under Article 16.
- K. Without prejudice to any other right or remedy, if a party has failed to obtain required insurance, the other party may elect (but is in no way obligated) to obtain equivalent insurance to protect such other party's interests at the expense of the party who was required to provide such coverage, and the Contract Price will be adjusted accordingly.

- L. Owner does not represent that insurance coverage and limits established in this Contract necessarily will be adequate to protect Contractor or Contractor's interests. Contractor is responsible for determining whether such coverage and limits are adequate to protect its interests, and for obtaining and maintaining any additional insurance that Contractor deems necessary.
- M. The insurance and insurance limits required herein will not be deemed as a limitation on Contractor's liability, or that of its Subcontractors or Suppliers, under the indemnities granted to Owner and other individuals and entities in the Contract or otherwise.
- N. All the policies of insurance required to be purchased and maintained under this Contract will contain a provision or endorsement that the coverage afforded will not be canceled, or renewal refused, until at least 10 days prior written notice has been given to the purchasing policyholder. Within three days of receipt of any such written notice, the purchasing policyholder shall provide a copy of the notice to each other insured and Engineer.

6.03 Contractor's Insurance

- A. *Required Insurance:* Contractor shall purchase and maintain Worker's Compensation, Commercial General Liability, and other insurance pursuant to the specific requirements of the Supplementary Conditions.
- B. *General Provisions:* The policies of insurance required by this Paragraph 6.03 as supplemented must:
 - 1. include at least the specific coverages required;
 - 2. be written for not less than the limits provided, or those required by Laws or Regulations, whichever is greater;
 - 3. remain in effect at least until the Work is complete (as set forth in Paragraph 15.06.D), and longer if expressly required elsewhere in this Contract, and at all times thereafter when Contractor may be correcting, removing, or replacing defective Work as a warranty or correction obligation, or otherwise, or returning to the Site to conduct other tasks arising from the Contract;
 - 4. apply with respect to the performance of the Work, whether such performance is by Contractor, any Subcontractor or Supplier, or by anyone directly or indirectly employed by any of them to perform any of the Work, or by anyone for whose acts any of them may be liable; and
 - 5. include all necessary endorsements to support the stated requirements.
- C. *Additional Insureds:* The Contractor's commercial general liability, automobile liability, employer's liability, umbrella or excess, pollution liability, and unmanned aerial vehicle liability policies, if required by this Contract, must:
 - 1. include and list as additional insureds Owner and Engineer, and any individuals or entities identified as additional insureds in the Supplementary Conditions;
 - 2. include coverage for the respective officers, directors, members, partners, employees, and consultants of all such additional insureds;
 - 3. afford primary coverage to these additional insureds for all claims covered thereby (including as applicable those arising from both ongoing and completed operations);

4. not seek contribution from insurance maintained by the additional insured; and
5. as to commercial general liability insurance, apply to additional insureds with respect to liability caused in whole or in part by Contractor's acts or omissions, or the acts and omissions of those working on Contractor's behalf, in the performance of Contractor's operations.

6.04 *Builder's Risk and Other Property Insurance*

- A. *Builder's Risk*: Unless otherwise provided in the Supplementary Conditions, Contractor shall purchase and maintain builder's risk insurance upon the Work on a completed value basis, in the amount of the Work's full insurable replacement cost (subject to such deductible amounts as may be provided in the Supplementary Conditions or required by Laws and Regulations). The specific requirements applicable to the builder's risk insurance are set forth in the Supplementary Conditions.
- B. *Property Insurance for Facilities of Owner Where Work Will Occur*: Owner is responsible for obtaining and maintaining property insurance covering each existing structure, building, or facility in which any part of the Work will occur, or to which any part of the Work will attach or be adjoined. Such property insurance will be written on a special perils (all-risk) form, on a replacement cost basis, providing coverage consistent with that required for the builder's risk insurance, and will be maintained until the Work is complete, as set forth in Paragraph 15.06.D.
- C. *Property Insurance for Substantially Complete Facilities*: Promptly after Substantial Completion, and before actual occupancy or use of the substantially completed Work, Owner will obtain property insurance for such substantially completed Work, and maintain such property insurance at least until the Work is complete, as set forth in Paragraph 15.06.D. Such property insurance will be written on a special perils (all-risk) form, on a replacement cost basis, and provide coverage consistent with that required for the builder's risk insurance. The builder's risk insurance may terminate upon written confirmation of Owner's procurement of such property insurance.
- D. *Partial Occupancy or Use by Owner*: If Owner will occupy or use a portion or portions of the Work prior to Substantial Completion of all the Work, as provided in Paragraph 15.04, then Owner (directly, if it is the purchaser of the builder's risk policy, or through Contractor) will provide advance notice of such occupancy or use to the builder's risk insurer, and obtain an endorsement consenting to the continuation of coverage prior to commencing such partial occupancy or use.
- E. *Insurance of Other Property; Additional Insurance*: If the express insurance provisions of the Contract do not require or address the insurance of a property item or interest, then the entity or individual owning such property item will be responsible for insuring it. If Contractor elects to obtain other special insurance to be included in or supplement the builder's risk or property insurance policies provided under this Paragraph 6.04, it may do so at Contractor's expense.

6.05 *Property Losses; Subrogation*

- A. The builder's risk insurance policy purchased and maintained in accordance with Paragraph 6.04 (or an installation floater policy if authorized by the Supplementary Conditions), will contain provisions to the effect that in the event of payment of any loss or damage the insurer will have no rights of recovery against any insureds thereunder, or against

Engineer or its consultants, or their officers, directors, members, partners, employees, agents, consultants, or subcontractors.

1. Owner and Contractor waive all rights against each other and the respective officers, directors, members, partners, employees, agents, consultants, and subcontractors of each and any of them, for all losses and damages caused by, arising out of, or resulting from any of the perils, risks, or causes of loss covered by such policies and any other property insurance applicable to the Work; and, in addition, waive all such rights against Engineer, its consultants, all individuals or entities identified in the Supplementary Conditions as builder's risk or installation floater insureds, and the officers, directors, members, partners, employees, agents, consultants, and subcontractors of each and any of them, under such policies for losses and damages so caused.
 2. None of the above waivers extends to the rights that any party making such waiver may have to the proceeds of insurance held by Owner or Contractor as trustee or fiduciary, or otherwise payable under any policy so issued.
- B. Any property insurance policy maintained by Owner covering any loss, damage, or consequential loss to Owner's existing structures, buildings, or facilities in which any part of the Work will occur, or to which any part of the Work will attach or adjoin; to adjacent structures, buildings, or facilities of Owner; or to part or all of the completed or substantially completed Work, during partial occupancy or use pursuant to Paragraph 15.04, after Substantial Completion pursuant to Paragraph 15.03, or after final payment pursuant to Paragraph 15.06, will contain provisions to the effect that in the event of payment of any loss or damage the insurer will have no rights of recovery against any insureds thereunder, or against Contractor, Subcontractors, or Engineer, or the officers, directors, members, partners, employees, agents, consultants, or subcontractors of each and any of them, and that the insured is allowed to waive the insurer's rights of subrogation in a written contract executed prior to the loss, damage, or consequential loss.
1. Owner waives all rights against Contractor, Subcontractors, and Engineer, and the officers, directors, members, partners, employees, agents, consultants and subcontractors of each and any of them, for all losses and damages caused by, arising out of, or resulting from fire or any of the perils, risks, or causes of loss covered by such policies.
- C. The waivers in this Paragraph 6.05 include the waiver of rights due to business interruption, loss of use, or other consequential loss extending beyond direct physical loss or damage to Owner's property or the Work caused by, arising out of, or resulting from fire or other insured peril, risk, or cause of loss.
- D. Contractor shall be responsible for assuring that each Subcontract contains provisions whereby the Subcontractor waives all rights against Owner, Contractor, all individuals or entities identified in the Supplementary Conditions as insureds, the Engineer and its consultants, and the officers, directors, members, partners, employees, agents, consultants, and subcontractors of each and any of them, for all losses and damages caused by, arising out of, relating to, or resulting from fire or other peril, risk, or cause of loss covered by builder's risk insurance, installation floater, and any other property insurance applicable to the Work.

6.06 *Receipt and Application of Property Insurance Proceeds*

- A. Any insured loss under the builder's risk and other policies of property insurance required by Paragraph 6.04 will be adjusted and settled with the named insured that purchased the policy. Such named insured shall act as fiduciary for the other insureds, and give notice to such other insureds that adjustment and settlement of a claim is in progress. Any other insured may state its position regarding a claim for insured loss in writing within 15 days after notice of such claim.
- B. Proceeds for such insured losses may be made payable by the insurer either jointly to multiple insureds, or to the named insured that purchased the policy in its own right and as fiduciary for other insureds, subject to the requirements of any applicable mortgage clause. A named insured receiving insurance proceeds under the builder's risk and other policies of insurance required by Paragraph 6.04 shall maintain such proceeds in a segregated account, and distribute such proceeds in accordance with such agreement as the parties in interest may reach, or as otherwise required under the dispute resolution provisions of this Contract or applicable Laws and Regulations.
- C. If no other special agreement is reached, Contractor shall repair or replace the damaged Work, using allocated insurance proceeds.

ARTICLE 7—CONTRACTOR'S RESPONSIBILITIES

7.01 *Contractor's Means and Methods of Construction*

- A. Contractor shall be solely responsible for the means, methods, techniques, sequences, and procedures of construction.
- B. If the Contract Documents note, or Contractor determines, that professional engineering or other design services are needed to carry out Contractor's responsibilities for construction means, methods, techniques, sequences, and procedures, or for Site safety, then Contractor shall cause such services to be provided by a properly licensed design professional, at Contractor's expense. Such services are not Owner-delegated professional design services under this Contract, and neither Owner nor Engineer has any responsibility with respect to (1) Contractor's determination of the need for such services, (2) the qualifications or licensing of the design professionals retained or employed by Contractor, (3) the performance of such services, or (4) any errors, omissions, or defects in such services.

7.02 *Supervision and Superintendence*

- A. Contractor shall supervise, inspect, and direct the Work competently and efficiently, devoting such attention thereto and applying such skills and expertise as may be necessary to perform the Work in accordance with the Contract Documents.
- B. At all times during the progress of the Work, Contractor shall assign a competent resident superintendent who will not be replaced without written notice to Owner and Engineer except under extraordinary circumstances.

7.03 *Labor; Working Hours*

- A. Contractor shall provide competent, suitably qualified personnel to survey and lay out the Work and perform construction as required by the Contract Documents. Contractor shall maintain good discipline and order at the Site.

- B. Contractor shall be fully responsible to Owner and Engineer for all acts and omissions of Contractor's employees; of Suppliers and Subcontractors, and their employees; and of any other individuals or entities performing or furnishing any of the Work, just as Contractor is responsible for Contractor's own acts and omissions.
- C. Except as otherwise required for the safety or protection of persons or the Work or property at the Site or adjacent thereto, and except as otherwise stated in the Contract Documents, all Work at the Site will be performed during regular working hours, Monday through Friday. Contractor will not perform Work on a Saturday, Sunday, or any legal holiday. Contractor may perform Work outside regular working hours or on Saturdays, Sundays, or legal holidays only with Owner's written consent, which will not be unreasonably withheld.

7.04 *Services, Materials, and Equipment*

- A. Unless otherwise specified in the Contract Documents, Contractor shall provide and assume full responsibility for all services, materials, equipment, labor, transportation, construction equipment and machinery, tools, appliances, fuel, power, light, heat, telephone, water, sanitary facilities, temporary facilities, and all other facilities and incidentals necessary for the performance, testing, start up, and completion of the Work, whether or not such items are specifically called for in the Contract Documents.
- B. All materials and equipment incorporated into the Work must be new and of good quality, except as otherwise provided in the Contract Documents. All special warranties and guarantees required by the Specifications will expressly run to the benefit of Owner. If required by Engineer, Contractor shall furnish satisfactory evidence (including reports of required tests) as to the source, kind, and quality of materials and equipment.
- C. All materials and equipment must be stored, applied, installed, connected, erected, protected, used, cleaned, and conditioned in accordance with instructions of the applicable Supplier, except as otherwise may be provided in the Contract Documents.

7.05 *"Or Equals"*

- A. *Contractor's Request; Governing Criteria:* Whenever an item of equipment or material is specified or described in the Contract Documents by using the names of one or more proprietary items or specific Suppliers, the Contract Price has been based upon Contractor furnishing such item as specified. The specification or description of such an item is intended to establish the type, function, appearance, and quality required. Unless the specification or description contains or is followed by words reading that no like, equivalent, or "or equal" item is permitted, Contractor may request that Engineer authorize the use of other items of equipment or material, or items from other proposed Suppliers, under the circumstances described below.
 - 1. If Engineer in its sole discretion determines that an item of equipment or material proposed by Contractor is functionally equal to that named and sufficiently similar so that no change in related Work will be required, Engineer will deem it an "or equal" item. For the purposes of this paragraph, a proposed item of equipment or material will be considered functionally equal to an item so named if:
 - a. in the exercise of reasonable judgment Engineer determines that the proposed item:
 - 1) is at least equal in materials of construction, quality, durability, appearance, strength, and design characteristics;

- 2) will reliably perform at least equally well the function and achieve the results imposed by the design concept of the completed Project as a functioning whole;
 - 3) has a proven record of performance and availability of responsive service; and
 - 4) is not objectionable to Owner.
- b. Contractor certifies that, if the proposed item is approved and incorporated into the Work:
- 1) there will be no increase in cost to the Owner or increase in Contract Times; and
 - 2) the item will conform substantially to the detailed requirements of the item named in the Contract Documents.
- B. *Contractor's Expense:* Contractor shall provide all data in support of any proposed "or equal" item at Contractor's expense.
- C. *Engineer's Evaluation and Determination:* Engineer will be allowed a reasonable time to evaluate each "or-equal" request. Engineer may require Contractor to furnish additional data about the proposed "or-equal" item. Engineer will be the sole judge of acceptability. No "or-equal" item will be ordered, furnished, installed, or utilized until Engineer's review is complete and Engineer determines that the proposed item is an "or-equal," which will be evidenced by an approved Shop Drawing or other written communication. Engineer will advise Contractor in writing of any negative determination.
- D. *Effect of Engineer's Determination:* Neither approval nor denial of an "or-equal" request will result in any change in Contract Price. The Engineer's denial of an "or-equal" request will be final and binding, and may not be reversed through an appeal under any provision of the Contract.
- E. *Treatment as a Substitution Request:* If Engineer determines that an item of equipment or material proposed by Contractor does not qualify as an "or-equal" item, Contractor may request that Engineer consider the item a proposed substitute pursuant to Paragraph 7.06.

7.06 *Substitutes*

- A. *Contractor's Request; Governing Criteria:* Unless the specification or description of an item of equipment or material required to be furnished under the Contract Documents contains or is followed by words reading that no substitution is permitted, Contractor may request that Engineer authorize the use of other items of equipment or material under the circumstances described below. To the extent possible such requests must be made before commencement of related construction at the Site.
1. Contractor shall submit sufficient information as provided below to allow Engineer to determine if the item of material or equipment proposed is functionally equivalent to that named and an acceptable substitute therefor. Engineer will not accept requests for review of proposed substitute items of equipment or material from anyone other than Contractor.
 2. The requirements for review by Engineer will be as set forth in Paragraph 7.06.B, as supplemented by the Specifications, and as Engineer may decide is appropriate under the circumstances.

3. Contractor shall make written application to Engineer for review of a proposed substitute item of equipment or material that Contractor seeks to furnish or use. The application:
 - a. will certify that the proposed substitute item will:
 - 1) perform adequately the functions and achieve the results called for by the general design;
 - 2) be similar in substance to the item specified; and
 - 3) be suited to the same use as the item specified.
 - b. will state:
 - 1) the extent, if any, to which the use of the proposed substitute item will necessitate a change in Contract Times;
 - 2) whether use of the proposed substitute item in the Work will require a change in any of the Contract Documents (or in the provisions of any other direct contract with Owner for other work on the Project) to adapt the design to the proposed substitute item; and
 - 3) whether incorporation or use of the proposed substitute item in connection with the Work is subject to payment of any license fee or royalty.
 - c. will identify:
 - 1) all variations of the proposed substitute item from the item specified; and
 - 2) available engineering, sales, maintenance, repair, and replacement services.
 - d. will contain an itemized estimate of all costs or credits that will result directly or indirectly from use of such substitute item, including but not limited to changes in Contract Price, shared savings, costs of redesign, and claims of other contractors affected by any resulting change.
- B. *Engineer's Evaluation and Determination*: Engineer will be allowed a reasonable time to evaluate each substitute request, and to obtain comments and direction from Owner. Engineer may require Contractor to furnish additional data about the proposed substitute item. Engineer will be the sole judge of acceptability. No substitute will be ordered, furnished, installed, or utilized until Engineer's review is complete and Engineer determines that the proposed item is an acceptable substitute. Engineer's determination will be evidenced by a Field Order or a proposed Change Order accounting for the substitution itself and all related impacts, including changes in Contract Price or Contract Times. Engineer will advise Contractor in writing of any negative determination.
- C. *Special Guarantee*: Owner may require Contractor to furnish at Contractor's expense a special performance guarantee or other surety with respect to any substitute.
- D. *Reimbursement of Engineer's Cost*: Engineer will record Engineer's costs in evaluating a substitute proposed or submitted by Contractor. Whether or not Engineer approves a substitute so proposed or submitted by Contractor, Contractor shall reimburse Owner for the reasonable charges of Engineer for evaluating each such proposed substitute. Contractor shall also reimburse Owner for the reasonable charges of Engineer for making changes in the Contract Documents (or in the provisions of any other direct contract with Owner) resulting from the acceptance of each proposed substitute.

- E. *Contractor's Expense*: Contractor shall provide all data in support of any proposed substitute at Contractor's expense.
- F. *Effect of Engineer's Determination*: If Engineer approves the substitution request, Contractor shall execute the proposed Change Order and proceed with the substitution. The Engineer's denial of a substitution request will be final and binding, and may not be reversed through an appeal under any provision of the Contract. Contractor may challenge the scope of reimbursement costs imposed under Paragraph 7.06.D, by timely submittal of a Change Proposal.

7.07 *Concerning Subcontractors and Suppliers*

- A. Contractor may retain Subcontractors and Suppliers for the performance of parts of the Work. Such Subcontractors and Suppliers must be acceptable to Owner. The Contractor's retention of a Subcontractor or Supplier for the performance of parts of the Work will not relieve Contractor's obligation to Owner to perform and complete the Work in accordance with the Contract Documents.
- B. Contractor shall retain specific Subcontractors and Suppliers for the performance of designated parts of the Work if required by the Contract to do so.
- C. Subsequent to the submittal of Contractor's Bid or final negotiation of the terms of the Contract, Owner may not require Contractor to retain any Subcontractor or Supplier to furnish or perform any of the Work against which Contractor has reasonable objection.
- D. Prior to entry into any binding subcontract or purchase order, Contractor shall submit to Owner the identity of the proposed Subcontractor or Supplier (unless Owner has already deemed such proposed Subcontractor or Supplier acceptable during the bidding process or otherwise). Such proposed Subcontractor or Supplier shall be deemed acceptable to Owner unless Owner raises a substantive, reasonable objection within 5 days.
- E. Owner may require the replacement of any Subcontractor or Supplier. Owner also may require Contractor to retain specific replacements; provided, however, that Owner may not require a replacement to which Contractor has a reasonable objection. If Contractor has submitted the identity of certain Subcontractors or Suppliers for acceptance by Owner, and Owner has accepted it (either in writing or by failing to make written objection thereto), then Owner may subsequently revoke the acceptance of any such Subcontractor or Supplier so identified solely on the basis of substantive, reasonable objection after due investigation. Contractor shall submit an acceptable replacement for the rejected Subcontractor or Supplier.
- F. If Owner requires the replacement of any Subcontractor or Supplier retained by Contractor to perform any part of the Work, then Contractor shall be entitled to an adjustment in Contract Price or Contract Times, with respect to the replacement; and Contractor shall initiate a Change Proposal for such adjustment within 30 days of Owner's requirement of replacement.
- G. No acceptance by Owner of any such Subcontractor or Supplier, whether initially or as a replacement, will constitute a waiver of the right of Owner to the completion of the Work in accordance with the Contract Documents.

- H. On a monthly basis, Contractor shall submit to Engineer a complete list of all Subcontractors and Suppliers having a direct contract with Contractor, and of all other Subcontractors and Suppliers known to Contractor at the time of submittal.
- I. Contractor shall be solely responsible for scheduling and coordinating the work of Subcontractors and Suppliers.
- J. The divisions and sections of the Specifications and the identifications of any Drawings do not control Contractor in dividing the Work among Subcontractors or Suppliers, or in delineating the Work to be performed by any specific trade.
- K. All Work performed for Contractor by a Subcontractor or Supplier must be pursuant to an appropriate contractual agreement that specifically binds the Subcontractor or Supplier to the applicable terms and conditions of the Contract for the benefit of Owner and Engineer.
- L. Owner may furnish to any Subcontractor or Supplier, to the extent practicable, information about amounts paid to Contractor for Work performed for Contractor by the Subcontractor or Supplier.
- M. Contractor shall restrict all Subcontractors and Suppliers from communicating with Engineer or Owner, except through Contractor or in case of an emergency, or as otherwise expressly allowed in this Contract.

7.08 *Patent Fees and Royalties*

- A. Contractor shall pay all license fees and royalties and assume all costs incident to the use in the performance of the Work or the incorporation in the Work of any invention, design, process, product, or device which is the subject of patent rights or copyrights held by others. If an invention, design, process, product, or device is specified in the Contract Documents for use in the performance of the Work and if, to the actual knowledge of Owner or Engineer, its use is subject to patent rights or copyrights calling for the payment of any license fee or royalty to others, the existence of such rights will be disclosed in the Contract Documents.
- B. To the fullest extent permitted by Laws and Regulations, Owner shall indemnify and hold harmless Contractor, and its officers, directors, members, partners, employees, agents, consultants, and subcontractors, from and against all claims, costs, losses, and damages (including but not limited to all fees and charges of engineers, architects, attorneys, and other professionals, and all court or arbitration or other dispute resolution costs) arising out of or relating to any infringement of patent rights or copyrights incident to the use in the performance of the Work or resulting from the incorporation in the Work of any invention, design, process, product, or device specified in the Contract Documents, but not identified as being subject to payment of any license fee or royalty to others required by patent rights or copyrights.
- C. To the fullest extent permitted by Laws and Regulations, Contractor shall indemnify and hold harmless Owner and Engineer, and the officers, directors, members, partners, employees, agents, consultants and subcontractors of each and any of them, from and against all claims, costs, losses, and damages (including but not limited to all fees and charges of engineers, architects, attorneys, and other professionals and all court or arbitration or other dispute resolution costs) arising out of or relating to any infringement of patent rights or copyrights incident to the use in the performance of the Work or resulting from the incorporation in the Work of any invention, design, process, product, or device not specified in the Contract Documents.

7.09 *Permits*

- A. Unless otherwise provided in the Contract Documents, Contractor shall obtain and pay for all construction permits, licenses, and certificates of occupancy. Owner shall assist Contractor, when necessary, in obtaining such permits and licenses. Contractor shall pay all governmental charges and inspection fees necessary for the prosecution of the Work which are applicable at the time of the submission of Contractor's Bid (or when Contractor became bound under a negotiated contract). Owner shall pay all charges of utility owners for connections for providing permanent service to the Work.

7.10 *Taxes*

- A. Contractor shall pay all sales, consumer, use, and other similar taxes required to be paid by Contractor in accordance with the Laws and Regulations of the place of the Project which are applicable during the performance of the Work.

7.11 *Laws and Regulations*

- A. Contractor shall give all notices required by and shall comply with all Laws and Regulations applicable to the performance of the Work. Neither Owner nor Engineer shall be responsible for monitoring Contractor's compliance with any Laws or Regulations.
- B. If Contractor performs any Work or takes any other action knowing or having reason to know that it is contrary to Laws or Regulations, Contractor shall bear all resulting costs and losses, and shall indemnify and hold harmless Owner and Engineer, and the officers, directors, members, partners, employees, agents, consultants, and subcontractors of each and any of them, from and against all claims, costs, losses, and damages (including but not limited to all fees and charges of engineers, architects, attorneys, and other professionals and all court or arbitration or other dispute resolution costs) arising out of or relating to such Work or other action. It is not Contractor's responsibility to make certain that the Work described in the Contract Documents is in accordance with Laws and Regulations, but this does not relieve Contractor of its obligations under Paragraph 3.03.
- C. Owner or Contractor may give written notice to the other party of any changes after the submission of Contractor's Bid (or after the date when Contractor became bound under a negotiated contract) in Laws or Regulations having an effect on the cost or time of performance of the Work, including but not limited to changes in Laws or Regulations having an effect on procuring permits and on sales, use, value-added, consumption, and other similar taxes. If Owner and Contractor are unable to agree on entitlement to or on the amount or extent, if any, of any adjustment in Contract Price or Contract Times resulting from such changes, then within 30 days of such written notice Contractor may submit a Change Proposal, or Owner may initiate a Claim.

7.12 *Record Documents*

- A. Contractor shall maintain in a safe place at the Site one printed record copy of all Drawings, Specifications, Addenda, Change Orders, Work Change Directives, Field Orders, written interpretations and clarifications, and approved Shop Drawings. Contractor shall keep such record documents in good order and annotate them to show changes made during construction. These record documents, together with all approved Samples, will be available to Engineer for reference. Upon completion of the Work, Contractor shall deliver these record documents to Engineer.

7.13 *Safety and Protection*

- A. Contractor shall be solely responsible for initiating, maintaining, and supervising all safety precautions and programs in connection with the Work. Such responsibility does not relieve Subcontractors of their responsibility for the safety of persons or property in the performance of their work, nor for compliance with applicable safety Laws and Regulations.
- B. Contractor shall designate a qualified and experienced safety representative whose duties and responsibilities are the prevention of Work-related accidents and the maintenance and supervision of safety precautions and programs.
- C. Contractor shall take all necessary precautions for the safety of, and shall provide the necessary protection to prevent damage, injury, or loss to:
 - 1. all persons on the Site or who may be affected by the Work;
 - 2. all the Work and materials and equipment to be incorporated therein, whether in storage on or off the Site; and
 - 3. other property at the Site or adjacent thereto, including trees, shrubs, lawns, walks, pavements, roadways, structures, other work in progress, utilities, and Underground Facilities not designated for removal, relocation, or replacement in the course of construction.
- D. All damage, injury, or loss to any property referred to in Paragraph 7.13.C.2 or 7.13.C.3 caused, directly or indirectly, in whole or in part, by Contractor, any Subcontractor, Supplier, or any other individual or entity directly or indirectly employed by any of them to perform any of the Work, or anyone for whose acts any of them may be liable, shall be remedied by Contractor at its expense (except damage or loss attributable to the fault of Drawings or Specifications or to the acts or omissions of Owner or Engineer or anyone employed by any of them, or anyone for whose acts any of them may be liable, and not attributable, directly or indirectly, in whole or in part, to the fault or negligence of Contractor or any Subcontractor, Supplier, or other individual or entity directly or indirectly employed by any of them).
- E. Contractor shall comply with all applicable Laws and Regulations relating to the safety of persons or property, or to the protection of persons or property from damage, injury, or loss; and shall erect and maintain all necessary safeguards for such safety and protection.
- F. Contractor shall notify Owner; the owners of adjacent property; the owners of Underground Facilities and other utilities (if the identity of such owners is known to Contractor); and other contractors and utility owners performing work at or adjacent to the Site, in writing, when Contractor knows that prosecution of the Work may affect them, and shall cooperate with them in the protection, removal, relocation, and replacement of their property or work in progress.
- G. Contractor shall comply with the applicable requirements of Owner's safety programs, if any. Any Owner's safety programs that are applicable to the Work are identified or included in the Supplementary Conditions or Specifications.
- H. Contractor shall inform Owner and Engineer of the specific requirements of Contractor's safety program with which Owner's and Engineer's employees and representatives must comply while at the Site.

- I. Contractor's duties and responsibilities for safety and protection will continue until all the Work is completed, Engineer has issued a written notice to Owner and Contractor in accordance with Paragraph 15.06.C that the Work is acceptable, and Contractor has left the Site (except as otherwise expressly provided in connection with Substantial Completion).
- J. Contractor's duties and responsibilities for safety and protection will resume whenever Contractor or any Subcontractor or Supplier returns to the Site to fulfill warranty or correction obligations, or to conduct other tasks arising from the Contract Documents.

7.14 *Hazard Communication Programs*

- A. Contractor shall be responsible for coordinating any exchange of safety data sheets (formerly known as material safety data sheets) or other hazard communication information required to be made available to or exchanged between or among employers at the Site in accordance with Laws or Regulations.

7.15 *Emergencies*

- A. In emergencies affecting the safety or protection of persons or the Work or property at the Site or adjacent thereto, Contractor is obligated to act to prevent damage, injury, or loss. Contractor shall give Engineer prompt written notice if Contractor believes that any significant changes in the Work or variations from the Contract Documents have been caused by an emergency, or are required as a result of Contractor's response to an emergency. If Engineer determines that a change in the Contract Documents is required because of an emergency or Contractor's response, a Work Change Directive or Change Order will be issued.

7.16 *Submittals*

A. *Shop Drawing and Sample Requirements*

- 1. Before submitting a Shop Drawing or Sample, Contractor shall:
 - a. review and coordinate the Shop Drawing or Sample with other Shop Drawings and Samples and with the requirements of the Work and the Contract Documents;
 - b. determine and verify:
 - 1) all field measurements, quantities, dimensions, specified performance and design criteria, installation requirements, materials, catalog numbers, and similar information with respect to the Submittal;
 - 2) the suitability of all materials and equipment offered with respect to the indicated application, fabrication, shipping, handling, storage, assembly, and installation pertaining to the performance of the Work; and
 - 3) all information relative to Contractor's responsibilities for means, methods, techniques, sequences, and procedures of construction, and safety precautions and programs incident thereto;
 - c. confirm that the Submittal is complete with respect to all related data included in the Submittal.
- 2. Each Shop Drawing or Sample must bear a stamp or specific written certification that Contractor has satisfied Contractor's obligations under the Contract Documents with respect to Contractor's review of that Submittal, and that Contractor approves the Submittal.

3. With each Shop Drawing or Sample, Contractor shall give Engineer specific written notice of any variations that the Submittal may have from the requirements of the Contract Documents. This notice must be set forth in a written communication separate from the Submittal; and, in addition, in the case of a Shop Drawing by a specific notation made on the Shop Drawing itself.
- B. *Submittal Procedures for Shop Drawings and Samples:* Contractor shall label and submit Shop Drawings and Samples to Engineer for review and approval in accordance with the accepted Schedule of Submittals.
1. *Shop Drawings*
 - a. Contractor shall submit the number of copies required in the Specifications.
 - b. Data shown on the Shop Drawings must be complete with respect to quantities, dimensions, specified performance and design criteria, materials, and similar data to show Engineer the services, materials, and equipment Contractor proposes to provide, and to enable Engineer to review the information for the limited purposes required by Paragraph 7.16.C.
 2. *Samples*
 - a. Contractor shall submit the number of Samples required in the Specifications.
 - b. Contractor shall clearly identify each Sample as to material, Supplier, pertinent data such as catalog numbers, the use for which intended and other data as Engineer may require to enable Engineer to review the Submittal for the limited purposes required by Paragraph 7.16.C.
 3. Where a Shop Drawing or Sample is required by the Contract Documents or the Schedule of Submittals, any related Work performed prior to Engineer's review and approval of the pertinent submittal will be at the sole expense and responsibility of Contractor.
- C. *Engineer's Review of Shop Drawings and Samples*
1. Engineer will provide timely review of Shop Drawings and Samples in accordance with the accepted Schedule of Submittals. Engineer's review and approval will be only to determine if the items covered by the Submittals will, after installation or incorporation in the Work, comply with the requirements of the Contract Documents, and be compatible with the design concept of the completed Project as a functioning whole as indicated by the Contract Documents.
 2. Engineer's review and approval will not extend to means, methods, techniques, sequences, or procedures of construction, or to safety precautions or programs incident thereto.
 3. Engineer's review and approval of a separate item as such will not indicate approval of the assembly in which the item functions.
 4. Engineer's review and approval of a Shop Drawing or Sample will not relieve Contractor from responsibility for any variation from the requirements of the Contract Documents unless Contractor has complied with the requirements of Paragraph 7.16.A.3 and Engineer has given written approval of each such variation by specific written notation thereof incorporated in or accompanying the Shop Drawing or Sample. Engineer will

document any such approved variation from the requirements of the Contract Documents in a Field Order or other appropriate Contract modification.

5. Engineer's review and approval of a Shop Drawing or Sample will not relieve Contractor from responsibility for complying with the requirements of Paragraphs 7.16.A and B.
6. Engineer's review and approval of a Shop Drawing or Sample, or of a variation from the requirements of the Contract Documents, will not, under any circumstances, change the Contract Times or Contract Price, unless such changes are included in a Change Order.
7. Neither Engineer's receipt, review, acceptance, or approval of a Shop Drawing or Sample will result in such item becoming a Contract Document.
8. Contractor shall perform the Work in compliance with the requirements and commitments set forth in approved Shop Drawings and Samples, subject to the provisions of Paragraph 7.16.C.4.

D. Resubmittal Procedures for Shop Drawings and Samples

1. Contractor shall make corrections required by Engineer and shall return the required number of corrected copies of Shop Drawings and submit, as required, new Samples for review and approval. Contractor shall direct specific attention in writing to revisions other than the corrections called for by Engineer on previous Submittals.
2. Contractor shall furnish required Shop Drawing and Sample submittals with sufficient information and accuracy to obtain required approval of an item with no more than two resubmittals. Engineer will record Engineer's time for reviewing a third or subsequent resubmittal of a Shop Drawing or Sample, and Contractor shall be responsible for Engineer's charges to Owner for such time. Owner may impose a set-off against payments due Contractor to secure reimbursement for such charges.
3. If Contractor requests a change of a previously approved Shop Drawing or Sample, Contractor shall be responsible for Engineer's charges to Owner for its review time, and Owner may impose a set-off against payments due Contractor to secure reimbursement for such charges, unless the need for such change is beyond the control of Contractor.

E. Submittals Other than Shop Drawings, Samples, and Owner-Delegated Designs

1. The following provisions apply to all Submittals other than Shop Drawings, Samples, and Owner-delegated designs:
 - a. Contractor shall submit all such Submittals to the Engineer in accordance with the Schedule of Submittals and pursuant to the applicable terms of the Contract Documents.
 - b. Engineer will provide timely review of all such Submittals in accordance with the Schedule of Submittals and return such Submittals with a notation of either Accepted or Not Accepted. Any such Submittal that is not returned within the time established in the Schedule of Submittals will be deemed accepted.
 - c. Engineer's review will be only to determine if the Submittal is acceptable under the requirements of the Contract Documents as to general form and content of the Submittal.

- d. If any such Submittal is not accepted, Contractor shall confer with Engineer regarding the reason for the non-acceptance, and resubmit an acceptable document.
 2. Procedures for the submittal and acceptance of the Progress Schedule, the Schedule of Submittals, and the Schedule of Values are set forth in Paragraphs 2.03, 2.04, and 2.05.
- F. Owner-delegated Designs: Submittals pursuant to Owner-delegated designs are governed by the provisions of Paragraph 7.19.

7.17 *Contractor's General Warranty and Guarantee*

- A. Contractor warrants and guarantees to Owner that all Work will be in accordance with the Contract Documents and will not be defective. Engineer is entitled to rely on Contractor's warranty and guarantee.
- B. Owner's rights under this warranty and guarantee are in addition to, and are not limited by, Owner's rights under the correction period provisions of Paragraph 15.08. The time in which Owner may enforce its warranty and guarantee rights under this Paragraph 7.17 is limited only by applicable Laws and Regulations restricting actions to enforce such rights; provided, however, that after the end of the correction period under Paragraph 15.08:
1. Owner shall give Contractor written notice of any defective Work within 60 days of the discovery that such Work is defective; and
 2. Such notice will be deemed the start of an event giving rise to a Claim under Paragraph 12.01.B, such that any related Claim must be brought within 30 days of the notice.
- C. Contractor's warranty and guarantee hereunder excludes defects or damage caused by:
1. abuse, or improper modification, maintenance, or operation, by persons other than Contractor, Subcontractors, Suppliers, or any other individual or entity for whom Contractor is responsible; or
 2. normal wear and tear under normal usage.
- D. Contractor's obligation to perform and complete the Work in accordance with the Contract Documents is absolute. None of the following will constitute an acceptance of Work that is not in accordance with the Contract Documents, a release of Contractor's obligation to perform the Work in accordance with the Contract Documents, or a release of Owner's warranty and guarantee rights under this Paragraph 7.17:
1. Observations by Engineer;
 2. Recommendation by Engineer or payment by Owner of any progress or final payment;
 3. The issuance of a certificate of Substantial Completion by Engineer or any payment related thereto by Owner;
 4. Use or occupancy of the Work or any part thereof by Owner;
 5. Any review and approval of a Shop Drawing or Sample submittal;
 6. The issuance of a notice of acceptability by Engineer;
 7. The end of the correction period established in Paragraph 15.08;
 8. Any inspection, test, or approval by others; or

9. Any correction of defective Work by Owner.
- E. If the Contract requires the Contractor to accept the assignment of a contract entered into by Owner, then the specific warranties, guarantees, and correction obligations contained in the assigned contract will govern with respect to Contractor's performance obligations to Owner for the Work described in the assigned contract.

7.18 *Indemnification*

- A. To the fullest extent permitted by Laws and Regulations, and in addition to any other obligations of Contractor under the Contract or otherwise, Contractor shall indemnify and hold harmless Owner and Engineer, and the officers, directors, members, partners, employees, agents, consultants and subcontractors of each and any of them, from losses, damages, costs, and judgments (including but not limited to all fees and charges of engineers, architects, attorneys, and other professionals, and all court or arbitration or other dispute resolution costs) arising from third-party claims or actions relating to or resulting from the performance or furnishing of the Work, provided that any such claim, action, loss, cost, judgment or damage is attributable to bodily injury, sickness, disease, or death, or to damage to or destruction of tangible property (other than the Work itself), including the loss of use resulting therefrom, but only to the extent caused by any negligent act or omission of Contractor, any Subcontractor, any Supplier, or any individual or entity directly or indirectly employed by any of them to perform any of the Work, or anyone for whose acts any of them may be liable.
- B. In any and all claims against Owner or Engineer, or any of their officers, directors, members, partners, employees, agents, consultants, or subcontractors, by any employee (or the survivor or personal representative of such employee) of Contractor, any Subcontractor, any Supplier, or any individual or entity directly or indirectly employed by any of them to perform any of the Work, or anyone for whose acts any of them may be liable, the indemnification obligation under Paragraph 7.18.A will not be limited in any way by any limitation on the amount or type of damages, compensation, or benefits payable by or for Contractor or any such Subcontractor, Supplier, or other individual or entity under workers' compensation acts, disability benefit acts, or other employee benefit acts.

7.19 *Delegation of Professional Design Services*

- A. Owner may require Contractor to provide professional design services for a portion of the Work by express delegation in the Contract Documents. Such delegation will specify the performance and design criteria that such services must satisfy, and the Submittals that Contractor must furnish to Engineer with respect to the Owner-delegated design.
- B. Contractor shall cause such Owner-delegated professional design services to be provided pursuant to the professional standard of care by a properly licensed design professional, whose signature and seal must appear on all drawings, calculations, specifications, certifications, and Submittals prepared by such design professional. Such design professional must issue all certifications of design required by Laws and Regulations.
- C. If a Shop Drawing or other Submittal related to the Owner-delegated design is prepared by Contractor, a Subcontractor, or others for submittal to Engineer, then such Shop Drawing or other Submittal must bear the written approval of Contractor's design professional when submitted by Contractor to Engineer.

- D. Owner and Engineer shall be entitled to rely upon the adequacy, accuracy, and completeness of the services, certifications, and approvals performed or provided by the design professionals retained or employed by Contractor under an Owner-delegated design, subject to the professional standard of care and the performance and design criteria stated in the Contract Documents.
- E. Pursuant to this Paragraph 7.19, Engineer's review, approval, and other determinations regarding design drawings, calculations, specifications, certifications, and other Submittals furnished by Contractor pursuant to an Owner-delegated design will be only for the following limited purposes:
 - 1. Checking for conformance with the requirements of this Paragraph 7.19;
 - 2. Confirming that Contractor (through its design professionals) has used the performance and design criteria specified in the Contract Documents; and
 - 3. Establishing that the design furnished by Contractor is consistent with the design concept expressed in the Contract Documents.
- F. Contractor shall not be responsible for the adequacy of performance or design criteria specified by Owner or Engineer.
- G. Contractor is not required to provide professional services in violation of applicable Laws and Regulations.

ARTICLE 8—OTHER WORK AT THE SITE

8.01 *Other Work*

- A. In addition to and apart from the Work under the Contract Documents, the Owner may perform other work at or adjacent to the Site. Such other work may be performed by Owner's employees, or through contracts between the Owner and third parties. Owner may also arrange to have third-party utility owners perform work on their utilities and facilities at or adjacent to the Site.
- B. If Owner performs other work at or adjacent to the Site with Owner's employees, or through contracts for such other work, then Owner shall give Contractor written notice thereof prior to starting any such other work. If Owner has advance information regarding the start of any third-party utility work that Owner has arranged to take place at or adjacent to the Site, Owner shall provide such information to Contractor.
- C. Contractor shall afford proper and safe access to the Site to each contractor that performs such other work, each utility owner performing other work, and Owner, if Owner is performing other work with Owner's employees, and provide a reasonable opportunity for the introduction and storage of materials and equipment and the execution of such other work.
- D. Contractor shall do all cutting, fitting, and patching of the Work that may be required to properly connect or otherwise make its several parts come together and properly integrate with such other work. Contractor shall not endanger any work of others by cutting, excavating, or otherwise altering such work; provided, however, that Contractor may cut or alter others' work with the written consent of Engineer and the others whose work will be affected.

- E. If the proper execution or results of any part of Contractor's Work depends upon work performed by others, Contractor shall inspect such other work and promptly report to Engineer in writing any delays, defects, or deficiencies in such other work that render it unavailable or unsuitable for the proper execution and results of Contractor's Work. Contractor's failure to so report will constitute an acceptance of such other work as fit and proper for integration with Contractor's Work except for latent defects and deficiencies in such other work.
- F. The provisions of this article are not applicable to work that is performed by third-party utilities or other third-party entities without a contract with Owner, or that is performed without having been arranged by Owner. If such work occurs, then any related delay, disruption, or interference incurred by Contractor is governed by the provisions of Paragraph 4.05.C.3.

8.02 *Coordination*

- A. If Owner intends to contract with others for the performance of other work at or adjacent to the Site, to perform other work at or adjacent to the Site with Owner's employees, or to arrange to have utility owners perform work at or adjacent to the Site, the following will be set forth in the Supplementary Conditions or provided to Contractor prior to the start of any such other work:
 - 1. The identity of the individual or entity that will have authority and responsibility for coordination of the activities among the various contractors;
 - 2. An itemization of the specific matters to be covered by such authority and responsibility; and
 - 3. The extent of such authority and responsibilities.
- B. Unless otherwise provided in the Supplementary Conditions, Owner shall have sole authority and responsibility for such coordination.

8.03 *Legal Relationships*

- A. If, in the course of performing other work for Owner at or adjacent to the Site, the Owner's employees, any other contractor working for Owner, or any utility owner that Owner has arranged to perform work, causes damage to the Work or to the property of Contractor or its Subcontractors, or delays, disrupts, interferes with, or increases the scope or cost of the performance of the Work, through actions or inaction, then Contractor shall be entitled to an equitable adjustment in the Contract Price or the Contract Times. Contractor must submit any Change Proposal seeking an equitable adjustment in the Contract Price or the Contract Times under this paragraph within 30 days of the damaging, delaying, disrupting, or interfering event. The entitlement to, and extent of, any such equitable adjustment will take into account information (if any) regarding such other work that was provided to Contractor in the Contract Documents prior to the submittal of the Bid or the final negotiation of the terms of the Contract, and any remedies available to Contractor under Laws or Regulations concerning utility action or inaction. When applicable, any such equitable adjustment in Contract Price will be conditioned on Contractor assigning to Owner all Contractor's rights against such other contractor or utility owner with respect to the damage, delay, disruption, or interference that is the subject of the adjustment. Contractor's entitlement to an adjustment of the Contract Times or Contract Price is subject to the provisions of Paragraphs 4.05.D and 4.05.E.

- B. Contractor shall take reasonable and customary measures to avoid damaging, delaying, disrupting, or interfering with the work of Owner, any other contractor, or any utility owner performing other work at or adjacent to the Site.
 - 1. If Contractor fails to take such measures and as a result damages, delays, disrupts, or interferes with the work of any such other contractor or utility owner, then Owner may impose a set-off against payments due Contractor, and assign to such other contractor or utility owner the Owner's contractual rights against Contractor with respect to the breach of the obligations set forth in this Paragraph 8.03.B.
 - 2. When Owner is performing other work at or adjacent to the Site with Owner's employees, Contractor shall be liable to Owner for damage to such other work, and for the reasonable direct delay, disruption, and interference costs incurred by Owner as a result of Contractor's failure to take reasonable and customary measures with respect to Owner's other work. In response to such damage, delay, disruption, or interference, Owner may impose a set-off against payments due Contractor.
- C. If Contractor damages, delays, disrupts, or interferes with the work of any other contractor, or any utility owner performing other work at or adjacent to the Site, through Contractor's failure to take reasonable and customary measures to avoid such impacts, or if any claim arising out of Contractor's actions, inactions, or negligence in performance of the Work at or adjacent to the Site is made by any such other contractor or utility owner against Contractor, Owner, or Engineer, then Contractor shall (1) promptly attempt to settle the claim as to all parties through negotiations with such other contractor or utility owner, or otherwise resolve the claim by arbitration or other dispute resolution proceeding or at law, and (2) indemnify and hold harmless Owner and Engineer, and the officers, directors, members, partners, employees, agents, consultants and subcontractors of each and any of them from and against any such claims, and against all costs, losses, and damages (including but not limited to all fees and charges of engineers, architects, attorneys, and other professionals and all court or arbitration or other dispute resolution costs) arising out of or relating to such damage, delay, disruption, or interference.

ARTICLE 9—OWNER'S RESPONSIBILITIES

9.01 *Communications to Contractor*

- A. Except as otherwise provided in these General Conditions, Owner shall issue all communications to Contractor through Engineer.

9.02 *Replacement of Engineer*

- A. Owner may at its discretion appoint an engineer to replace Engineer, provided Contractor makes no reasonable objection to the replacement engineer. The replacement engineer's status under the Contract Documents will be that of the former Engineer.

9.03 *Furnish Data*

- A. Owner shall promptly furnish the data required of Owner under the Contract Documents.

9.04 *Pay When Due*

- A. Owner shall make payments to Contractor when they are due as provided in the Agreement.

- 9.05 *Lands and Easements; Reports, Tests, and Drawings*
- A. Owner's duties with respect to providing lands and easements are set forth in Paragraph 5.01.
 - B. Owner's duties with respect to providing engineering surveys to establish reference points are set forth in Paragraph 4.03.
 - C. Article 5 refers to Owner's identifying and making available to Contractor copies of reports of explorations and tests of conditions at the Site, and drawings of physical conditions relating to existing surface or subsurface structures at the Site.
- 9.06 *Insurance*
- A. Owner's responsibilities, if any, with respect to purchasing and maintaining liability and property insurance are set forth in Article 6.
- 9.07 *Change Orders*
- A. Owner's responsibilities with respect to Change Orders are set forth in Article 11.
- 9.08 *Inspections, Tests, and Approvals*
- A. Owner's responsibility with respect to certain inspections, tests, and approvals is set forth in Paragraph 14.02.B.
- 9.09 *Limitations on Owner's Responsibilities*
- A. The Owner shall not supervise, direct, or have control or authority over, nor be responsible for, Contractor's means, methods, techniques, sequences, or procedures of construction, or the safety precautions and programs incident thereto, or for any failure of Contractor to comply with Laws and Regulations applicable to the performance of the Work. Owner will not be responsible for Contractor's failure to perform the Work in accordance with the Contract Documents.
- 9.10 *Undisclosed Hazardous Environmental Condition*
- A. Owner's responsibility in respect to an undisclosed Hazardous Environmental Condition is set forth in Paragraph 5.06.
- 9.11 *Evidence of Financial Arrangements*
- A. Upon request of Contractor, Owner shall furnish Contractor reasonable evidence that financial arrangements have been made to satisfy Owner's obligations under the Contract (including obligations under proposed changes in the Work).
- 9.12 *Safety Programs*
- A. While at the Site, Owner's employees and representatives shall comply with the specific applicable requirements of Contractor's safety programs of which Owner has been informed.
 - B. Owner shall furnish copies of any applicable Owner safety programs to Contractor.

ARTICLE 10—ENGINEER'S STATUS DURING CONSTRUCTION

10.01 *Owner's Representative*

- A. Engineer will be Owner's representative during the construction period. The duties and responsibilities and the limitations of authority of Engineer as Owner's representative during construction are set forth in the Contract.

10.02 *Visits to Site*

- A. Engineer will make visits to the Site at intervals appropriate to the various stages of construction as Engineer deems necessary in order to observe, as an experienced and qualified design professional, the progress that has been made and the quality of the various aspects of Contractor's executed Work. Based on information obtained during such visits and observations, Engineer, for the benefit of Owner, will determine, in general, if the Work is proceeding in accordance with the Contract Documents. Engineer will not be required to make exhaustive or continuous inspections on the Site to check the quality or quantity of the Work. Engineer's efforts will be directed toward providing for Owner a greater degree of confidence that the completed Work will conform generally to the Contract Documents. On the basis of such visits and observations, Engineer will keep Owner informed of the progress of the Work and will endeavor to guard Owner against defective Work.
- B. Engineer's visits and observations are subject to all the limitations on Engineer's authority and responsibility set forth in Paragraph 10.07. Particularly, but without limitation, during or as a result of Engineer's visits or observations of Contractor's Work, Engineer will not supervise, direct, control, or have authority over or be responsible for Contractor's means, methods, techniques, sequences, or procedures of construction, or the safety precautions and programs incident thereto, or for any failure of Contractor to comply with Laws and Regulations applicable to the performance of the Work.

10.03 *Resident Project Representative*

- A. If Owner and Engineer have agreed that Engineer will furnish a Resident Project Representative to represent Engineer at the Site and assist Engineer in observing the progress and quality of the Work, then the authority and responsibilities of any such Resident Project Representative will be as provided in the Supplementary Conditions, and limitations on the responsibilities thereof will be as provided in the Supplementary Conditions and in Paragraph 10.07.
- B. If Owner designates an individual or entity who is not Engineer's consultant, agent, or employee to represent Owner at the Site, then the responsibilities and authority of such individual or entity will be as provided in the Supplementary Conditions.

10.04 *Engineer's Authority*

- A. Engineer has the authority to reject Work in accordance with Article 14.
- B. Engineer's authority as to Submittals is set forth in Paragraph 7.16.
- C. Engineer's authority as to design drawings, calculations, specifications, certifications and other Submittals from Contractor in response to Owner's delegation (if any) to Contractor of professional design services, is set forth in Paragraph 7.19.
- D. Engineer's authority as to changes in the Work is set forth in Article 11.

E. Engineer's authority as to Applications for Payment is set forth in Article 15.

10.05 *Determinations for Unit Price Work*

A. Engineer will determine the actual quantities and classifications of Unit Price Work performed by Contractor as set forth in Paragraph 13.03.

10.06 *Decisions on Requirements of Contract Documents and Acceptability of Work*

A. Engineer will render decisions regarding the requirements of the Contract Documents, and judge the acceptability of the Work, pursuant to the specific procedures set forth herein for initial interpretations, Change Proposals, and acceptance of the Work. In rendering such decisions and judgments, Engineer will not show partiality to Owner or Contractor, and will not be liable to Owner, Contractor, or others in connection with any proceedings, interpretations, decisions, or judgments conducted or rendered in good faith.

10.07 *Limitations on Engineer's Authority and Responsibilities*

A. Neither Engineer's authority or responsibility under this Article 10 or under any other provision of the Contract, nor any decision made by Engineer in good faith either to exercise or not exercise such authority or responsibility or the undertaking, exercise, or performance of any authority or responsibility by Engineer, will create, impose, or give rise to any duty in contract, tort, or otherwise owed by Engineer to Contractor, any Subcontractor, any Supplier, any other individual or entity, or to any surety for or employee or agent of any of them.

B. Engineer will not supervise, direct, control, or have authority over or be responsible for Contractor's means, methods, techniques, sequences, or procedures of construction, or the safety precautions and programs incident thereto, or for any failure of Contractor to comply with Laws and Regulations applicable to the performance of the Work. Engineer will not be responsible for Contractor's failure to perform the Work in accordance with the Contract Documents.

C. Engineer will not be responsible for the acts or omissions of Contractor or of any Subcontractor, any Supplier, or of any other individual or entity performing any of the Work.

D. Engineer's review of the final Application for Payment and accompanying documentation, and all maintenance and operating instructions, schedules, guarantees, bonds, certificates of inspection, tests and approvals, and other documentation required to be delivered by Contractor under Paragraph 15.06.A, will only be to determine generally that their content complies with the requirements of, and in the case of certificates of inspections, tests, and approvals, that the results certified indicate compliance with the Contract Documents.

E. The limitations upon authority and responsibility set forth in this Paragraph 10.07 also apply to the Resident Project Representative, if any.

10.08 *Compliance with Safety Program*

A. While at the Site, Engineer's employees and representatives will comply with the specific applicable requirements of Owner's and Contractor's safety programs of which Engineer has been informed.

ARTICLE 11—CHANGES TO THE CONTRACT

11.01 *Amending and Supplementing the Contract*

- A. The Contract may be amended or supplemented by a Change Order, a Work Change Directive, or a Field Order.
- B. If an amendment or supplement to the Contract includes a change in the Contract Price or the Contract Times, such amendment or supplement must be set forth in a Change Order.
- C. All changes to the Contract that involve (1) the performance or acceptability of the Work, (2) the design (as set forth in the Drawings, Specifications, or otherwise), or (3) other engineering or technical matters, must be supported by Engineer's recommendation. Owner and Contractor may amend other terms and conditions of the Contract without the recommendation of the Engineer.

11.02 *Change Orders*

- A. Owner and Contractor shall execute appropriate Change Orders covering:
 - 1. Changes in Contract Price or Contract Times which are agreed to by the parties, including any undisputed sum or amount of time for Work actually performed in accordance with a Work Change Directive;
 - 2. Changes in Contract Price resulting from an Owner set-off, unless Contractor has duly contested such set-off;
 - 3. Changes in the Work which are: (a) ordered by Owner pursuant to Paragraph 11.05, (b) required because of Owner's acceptance of defective Work under Paragraph 14.04 or Owner's correction of defective Work under Paragraph 14.07, or (c) agreed to by the parties, subject to the need for Engineer's recommendation if the change in the Work involves the design (as set forth in the Drawings, Specifications, or otherwise) or other engineering or technical matters; and
 - 4. Changes that embody the substance of any final and binding results under: Paragraph 11.03.B, resolving the impact of a Work Change Directive; Paragraph 11.09, concerning Change Proposals; Article 12, Claims; Paragraph 13.02.D, final adjustments resulting from allowances; Paragraph 13.03.D, final adjustments relating to determination of quantities for Unit Price Work; and similar provisions.
- B. If Owner or Contractor refuses to execute a Change Order that is required to be executed under the terms of Paragraph 11.02.A, it will be deemed to be of full force and effect, as if fully executed.

11.03 *Work Change Directives*

- A. A Work Change Directive will not change the Contract Price or the Contract Times but is evidence that the parties expect that the modification ordered or documented by a Work Change Directive will be incorporated in a subsequently issued Change Order, following negotiations by the parties as to the Work Change Directive's effect, if any, on the Contract Price and Contract Times; or, if negotiations are unsuccessful, by a determination under the terms of the Contract Documents governing adjustments, expressly including Paragraph 11.07 regarding change of Contract Price.

- B. If Owner has issued a Work Change Directive and:
 - 1. Contractor believes that an adjustment in Contract Times or Contract Price is necessary, then Contractor shall submit any Change Proposal seeking such an adjustment no later than 30 days after the completion of the Work set out in the Work Change Directive.
 - 2. Owner believes that an adjustment in Contract Times or Contract Price is necessary, then Owner shall submit any Claim seeking such an adjustment no later than 60 days after issuance of the Work Change Directive.

11.04 *Field Orders*

- A. Engineer may authorize minor changes in the Work if the changes do not involve an adjustment in the Contract Price or the Contract Times and are compatible with the design concept of the completed Project as a functioning whole as indicated by the Contract Documents. Such changes will be accomplished by a Field Order and will be binding on Owner and also on Contractor, which shall perform the Work involved promptly.
- B. If Contractor believes that a Field Order justifies an adjustment in the Contract Price or Contract Times, then before proceeding with the Work at issue, Contractor shall submit a Change Proposal as provided herein.

11.05 *Owner-Authorized Changes in the Work*

- A. Without invalidating the Contract and without notice to any surety, Owner may, at any time or from time to time, order additions, deletions, or revisions in the Work. Changes involving the design (as set forth in the Drawings, Specifications, or otherwise) or other engineering or technical matters will be supported by Engineer's recommendation.
- B. Such changes in the Work may be accomplished by a Change Order, if Owner and Contractor have agreed as to the effect, if any, of the changes on Contract Times or Contract Price; or by a Work Change Directive. Upon receipt of any such document, Contractor shall promptly proceed with the Work involved; or, in the case of a deletion in the Work, promptly cease construction activities with respect to such deleted Work. Added or revised Work must be performed under the applicable conditions of the Contract Documents.
- C. Nothing in this Paragraph 11.05 obligates Contractor to undertake work that Contractor reasonably concludes cannot be performed in a manner consistent with Contractor's safety obligations under the Contract Documents or Laws and Regulations.

11.06 *Unauthorized Changes in the Work*

- A. Contractor shall not be entitled to an increase in the Contract Price or an extension of the Contract Times with respect to any work performed that is not required by the Contract Documents, as amended, modified, or supplemented, except in the case of an emergency as provided in Paragraph 7.15 or in the case of uncovering Work as provided in Paragraph 14.05.C.2.

11.07 *Change of Contract Price*

- A. The Contract Price may only be changed by a Change Order. Any Change Proposal for an adjustment in the Contract Price must comply with the provisions of Paragraph 11.09. Any Claim for an adjustment of Contract Price must comply with the provisions of Article 12.
- B. An adjustment in the Contract Price will be determined as follows:

1. Where the Work involved is covered by unit prices contained in the Contract Documents, then by application of such unit prices to the quantities of the items involved (subject to the provisions of Paragraph 13.03);
 2. Where the Work involved is not covered by unit prices contained in the Contract Documents, then by a mutually agreed lump sum (which may include an allowance for overhead and profit not necessarily in accordance with Paragraph 11.07.C.2); or
 3. Where the Work involved is not covered by unit prices contained in the Contract Documents and the parties do not reach mutual agreement to a lump sum, then on the basis of the Cost of the Work (determined as provided in Paragraph 13.01) plus a Contractor's fee for overhead and profit (determined as provided in Paragraph 11.07.C).
- C. *Contractor's Fee:* When applicable, the Contractor's fee for overhead and profit will be determined as follows:
1. A mutually acceptable fixed fee; or
 2. If a fixed fee is not agreed upon, then a fee based on the following percentages of the various portions of the Cost of the Work:
 - a. For costs incurred under Paragraphs 13.01.B.1 and 13.01.B.2, the Contractor's fee will be 15 percent;
 - b. For costs incurred under Paragraph 13.01.B.3, the Contractor's fee will be 5 percent;
 - c. Where one or more tiers of subcontracts are on the basis of Cost of the Work plus a fee and no fixed fee is agreed upon, the intent of Paragraphs 11.07.C.2.a and 11.07.C.2.b is that the Contractor's fee will be based on: (1) a fee of 15 percent of the costs incurred under Paragraphs 13.01.B.1 and 13.01.B.2 by the Subcontractor that actually performs the Work, at whatever tier, and (2) with respect to Contractor itself and to any Subcontractors of a tier higher than that of the Subcontractor that actually performs the Work, a fee of 5 percent of the amount (fee plus underlying costs incurred) attributable to the next lower tier Subcontractor; provided, however, that for any such subcontracted Work the maximum total fee to be paid by Owner will be no greater than 27 percent of the costs incurred by the Subcontractor that actually performs the Work;
 - d. No fee will be payable on the basis of costs itemized under Paragraphs 13.01.B.4, 13.01.B.5, and 13.01.C;
 - e. The amount of credit to be allowed by Contractor to Owner for any change which results in a net decrease in Cost of the Work will be the amount of the actual net decrease in Cost of the Work and a deduction of an additional amount equal to 5 percent of such actual net decrease in Cost of the Work; and
 - f. When both additions and credits are involved in any one change or Change Proposal, the adjustment in Contractor's fee will be computed by determining the sum of the costs in each of the cost categories in Paragraph 13.01.B (specifically, payroll costs, Paragraph 13.01.B.1; incorporated materials and equipment costs, Paragraph 13.01.B.2; Subcontract costs, Paragraph 13.01.B.3; special consultants costs, Paragraph 13.01.B.4; and other costs, Paragraph 13.01.B.5) and applying to each such cost category sum the appropriate fee from Paragraphs 11.07.C.2.a through 11.07.C.2.e, inclusive.

11.08 *Change of Contract Times*

- A. The Contract Times may only be changed by a Change Order. Any Change Proposal for an adjustment in the Contract Times must comply with the provisions of Paragraph 11.09. Any Claim for an adjustment in the Contract Times must comply with the provisions of Article 12.
- B. Delay, disruption, and interference in the Work, and any related changes in Contract Times, are addressed in and governed by Paragraph 4.05.

11.09 *Change Proposals*

A. *Purpose and Content:* Contractor shall submit a Change Proposal to Engineer to request an adjustment in the Contract Times or Contract Price; contest an initial decision by Engineer concerning the requirements of the Contract Documents or relating to the acceptability of the Work under the Contract Documents; challenge a set-off against payment due; or seek other relief under the Contract. The Change Proposal will specify any proposed change in Contract Times or Contract Price, or other proposed relief, and explain the reason for the proposed change, with citations to any governing or applicable provisions of the Contract Documents. Each Change Proposal will address only one issue, or a set of closely related issues.

B. *Change Proposal Procedures*

1. *Submittal:* Contractor shall submit each Change Proposal to Engineer within 30 days after the start of the event giving rise thereto, or after such initial decision.
2. *Supporting Data:* The Contractor shall submit supporting data, including the proposed change in Contract Price or Contract Time (if any), to the Engineer and Owner within 15 days after the submittal of the Change Proposal.
 - a. Change Proposals based on or related to delay, interruption, or interference must comply with the provisions of Paragraphs 4.05.D and 4.05.E.
 - b. Change proposals related to a change of Contract Price must include full and detailed accounts of materials incorporated into the Work and labor and equipment used for the subject Work.

The supporting data must be accompanied by a written statement that the supporting data are accurate and complete, and that any requested time or price adjustment is the entire adjustment to which Contractor believes it is entitled as a result of said event.

3. *Engineer's Initial Review:* Engineer will advise Owner regarding the Change Proposal, and consider any comments or response from Owner regarding the Change Proposal. If in its discretion Engineer concludes that additional supporting data is needed before conducting a full review and making a decision regarding the Change Proposal, then Engineer may request that Contractor submit such additional supporting data by a date specified by Engineer, prior to Engineer beginning its full review of the Change Proposal.
4. *Engineer's Full Review and Action on the Change Proposal:* Upon receipt of Contractor's supporting data (including any additional data requested by Engineer), Engineer will conduct a full review of each Change Proposal and, within 30 days after such receipt of the Contractor's supporting data, either approve the Change Proposal in whole, deny it in whole, or approve it in part and deny it in part. Such actions must be in writing, with a copy provided to Owner and Contractor. If Engineer does not take action on the Change

Proposal within 30 days, then either Owner or Contractor may at any time thereafter submit a letter to the other party indicating that as a result of Engineer's inaction the Change Proposal is deemed denied, thereby commencing the time for appeal of the denial under Article 12.

5. *Binding Decision*: Engineer's decision is final and binding upon Owner and Contractor, unless Owner or Contractor appeals the decision by filing a Claim under Article 12.
- C. *Resolution of Certain Change Proposals*: If the Change Proposal does not involve the design (as set forth in the Drawings, Specifications, or otherwise), the acceptability of the Work, or other engineering or technical matters, then Engineer will notify the parties in writing that the Engineer is unable to resolve the Change Proposal. For purposes of further resolution of such a Change Proposal, such notice will be deemed a denial, and Contractor may choose to seek resolution under the terms of Article 12.
- D. *Post-Completion*: Contractor shall not submit any Change Proposals after Engineer issues a written recommendation of final payment pursuant to Paragraph 15.06.B.

11.10 *Notification to Surety*

- A. If the provisions of any bond require notice to be given to a surety of any change affecting the general scope of the Work or the provisions of the Contract Documents (including, but not limited to, Contract Price or Contract Times), the giving of any such notice will be Contractor's responsibility. The amount of each applicable bond will be adjusted to reflect the effect of any such change.

ARTICLE 12—CLAIMS

12.01 *Claims*

- A. *Claims Process*: The following disputes between Owner and Contractor are subject to the Claims process set forth in this article:
 1. Appeals by Owner or Contractor of Engineer's decisions regarding Change Proposals;
 2. Owner demands for adjustments in the Contract Price or Contract Times, or other relief under the Contract Documents;
 3. Disputes that Engineer has been unable to address because they do not involve the design (as set forth in the Drawings, Specifications, or otherwise), the acceptability of the Work, or other engineering or technical matters; and
 4. Subject to the waiver provisions of Paragraph 15.07, any dispute arising after Engineer has issued a written recommendation of final payment pursuant to Paragraph 15.06.B.
- B. *Submittal of Claim*: The party submitting a Claim shall deliver it directly to the other party to the Contract promptly (but in no event later than 30 days) after the start of the event giving rise thereto; in the case of appeals regarding Change Proposals within 30 days of the decision under appeal. The party submitting the Claim shall also furnish a copy to the Engineer, for its information only. The responsibility to substantiate a Claim rests with the party making the Claim. In the case of a Claim by Contractor seeking an increase in the Contract Times or Contract Price, Contractor shall certify that the Claim is made in good faith, that the supporting data are accurate and complete, and that to the best of Contractor's knowledge

and belief the amount of time or money requested accurately reflects the full amount to which Contractor is entitled.

- C. *Review and Resolution*: The party receiving a Claim shall review it thoroughly, giving full consideration to its merits. The two parties shall seek to resolve the Claim through the exchange of information and direct negotiations. The parties may extend the time for resolving the Claim by mutual agreement. All actions taken on a Claim will be stated in writing and submitted to the other party, with a copy to Engineer.
- D. *Mediation*
 - 1. At any time after initiation of a Claim, Owner and Contractor may mutually agree to mediation of the underlying dispute. The agreement to mediate will stay the Claim submittal and response process.
 - 2. If Owner and Contractor agree to mediation, then after 60 days from such agreement, either Owner or Contractor may unilaterally terminate the mediation process, and the Claim submittal and decision process will resume as of the date of the termination. If the mediation proceeds but is unsuccessful in resolving the dispute, the Claim submittal and decision process will resume as of the date of the conclusion of the mediation, as determined by the mediator.
 - 3. Owner and Contractor shall each pay one-half of the mediator's fees and costs.
- E. *Partial Approval*: If the party receiving a Claim approves the Claim in part and denies it in part, such action will be final and binding unless within 30 days of such action the other party invokes the procedure set forth in Article 17 for final resolution of disputes.
- F. *Denial of Claim*: If efforts to resolve a Claim are not successful, the party receiving the Claim may deny it by giving written notice of denial to the other party. If the receiving party does not take action on the Claim within 90 days, then either Owner or Contractor may at any time thereafter submit a letter to the other party indicating that as a result of the inaction, the Claim is deemed denied, thereby commencing the time for appeal of the denial. A denial of the Claim will be final and binding unless within 30 days of the denial the other party invokes the procedure set forth in Article 17 for the final resolution of disputes.
- G. *Final and Binding Results*: If the parties reach a mutual agreement regarding a Claim, whether through approval of the Claim, direct negotiations, mediation, or otherwise; or if a Claim is approved in part and denied in part, or denied in full, and such actions become final and binding; then the results of the agreement or action on the Claim will be incorporated in a Change Order or other written document to the extent they affect the Contract, including the Work, the Contract Times, or the Contract Price.

ARTICLE 13—COST OF THE WORK; ALLOWANCES; UNIT PRICE WORK

13.01 *Cost of the Work*

- A. *Purposes for Determination of Cost of the Work*: The term Cost of the Work means the sum of all costs necessary for the proper performance of the Work at issue, as further defined below. The provisions of this Paragraph 13.01 are used for two distinct purposes:
 - 1. To determine Cost of the Work when Cost of the Work is a component of the Contract Price, under cost-plus-fee, time-and-materials, or other cost-based terms; or

2. When needed to determine the value of a Change Order, Change Proposal, Claim, set-off, or other adjustment in Contract Price. When the value of any such adjustment is determined on the basis of Cost of the Work, Contractor is entitled only to those additional or incremental costs required because of the change in the Work or because of the event giving rise to the adjustment.
- B. *Costs Included:* Except as otherwise may be agreed to in writing by Owner, costs included in the Cost of the Work will be in amounts no higher than those commonly incurred in the locality of the Project, will not include any of the costs itemized in Paragraph 13.01.C, and will include only the following items:
1. Payroll costs for employees in the direct employ of Contractor in the performance of the Work under schedules of job classifications agreed upon by Owner and Contractor in advance of the subject Work. Such employees include, without limitation, superintendents, foremen, safety managers, safety representatives, and other personnel employed full time on the Work. Payroll costs for employees not employed full time on the Work will be apportioned on the basis of their time spent on the Work. Payroll costs include, but are not limited to, salaries and wages plus the cost of fringe benefits, which include social security contributions, unemployment, excise, and payroll taxes, workers' compensation, health and retirement benefits, sick leave, and vacation and holiday pay applicable thereto. The expenses of performing Work outside of regular working hours, on Saturday, Sunday, or legal holidays, will be included in the above to the extent authorized by Owner.
 2. Cost of all materials and equipment furnished and incorporated in the Work, including costs of transportation and storage thereof, and Suppliers' field services required in connection therewith. All cash discounts accrue to Contractor unless Owner deposits funds with Contractor with which to make payments, in which case the cash discounts will accrue to Owner. All trade discounts, rebates, and refunds and returns from sale of surplus materials and equipment will accrue to Owner, and Contractor shall make provisions so that they may be obtained.
 3. Payments made by Contractor to Subcontractors for Work performed by Subcontractors. If required by Owner, Contractor shall obtain competitive bids from subcontractors acceptable to Owner and Contractor and shall deliver such bids to Owner, which will then determine, with the advice of Engineer, which bids, if any, will be acceptable. If any subcontract provides that the Subcontractor is to be paid on the basis of Cost of the Work plus a fee, the Subcontractor's Cost of the Work and fee will be determined in the same manner as Contractor's Cost of the Work and fee as provided in this Paragraph 13.01.
 4. Costs of special consultants (including but not limited to engineers, architects, testing laboratories, surveyors, attorneys, and accountants) employed or retained for services specifically related to the Work.
 5. Other costs consisting of the following:
 - a. The proportion of necessary transportation, travel, and subsistence expenses of Contractor's employees incurred in discharge of duties connected with the Work.
 - b. Cost, including transportation and maintenance, of all materials, supplies, equipment, machinery, appliances, office, and temporary facilities at the Site, which are

consumed in the performance of the Work, and cost, less market value, of such items used but not consumed which remain the property of Contractor.

- 1) In establishing included costs for materials such as scaffolding, plating, or sheeting, consideration will be given to the actual or the estimated life of the material for use on other projects; or rental rates may be established on the basis of purchase or salvage value of such items, whichever is less. Contractor will not be eligible for compensation for such items in an amount that exceeds the purchase cost of such item.

c. *Construction Equipment Rental*

- 1) Rentals of all construction equipment and machinery, and the parts thereof, in accordance with rental agreements approved by Owner as to price (including any surcharge or special rates applicable to overtime use of the construction equipment or machinery), and the costs of transportation, loading, unloading, assembly, dismantling, and removal thereof. All such costs will be in accordance with the terms of said rental agreements. The rental of any such equipment, machinery, or parts must cease when the use thereof is no longer necessary for the Work.
- 2) Costs for equipment and machinery owned by Contractor or a Contractor-related entity will be paid at a rate shown for such equipment in the equipment rental rate book specified in the Supplementary Conditions. An hourly rate will be computed by dividing the monthly rates by 176. These computed rates will include all operating costs.
- 3) With respect to Work that is the result of a Change Order, Change Proposal, Claim, set-off, or other adjustment in Contract Price ("changed Work"), included costs will be based on the time the equipment or machinery is in use on the changed Work and the costs of transportation, loading, unloading, assembly, dismantling, and removal when directly attributable to the changed Work. The cost of any such equipment or machinery, or parts thereof, must cease to accrue when the use thereof is no longer necessary for the changed Work.

- d. Sales, consumer, use, and other similar taxes related to the Work, and for which Contractor is liable, as imposed by Laws and Regulations.
- e. Deposits lost for causes other than negligence of Contractor, any Subcontractor, or anyone directly or indirectly employed by any of them or for whose acts any of them may be liable, and royalty payments and fees for permits and licenses.
- f. Losses and damages (and related expenses) caused by damage to the Work, not compensated by insurance or otherwise, sustained by Contractor in connection with the performance of the Work (except losses and damages within the deductible amounts of builder's risk or other property insurance established in accordance with Paragraph 6.04), provided such losses and damages have resulted from causes other than the negligence of Contractor, any Subcontractor, or anyone directly or indirectly employed by any of them or for whose acts any of them may be liable. Such losses include settlements made with the written consent and approval of Owner. No such losses, damages, and expenses will be included in the Cost of the Work for the purpose of determining Contractor's fee.

- g. The cost of utilities, fuel, and sanitary facilities at the Site.
- h. Minor expenses such as communication service at the Site, express and courier services, and similar petty cash items in connection with the Work.
- i. The costs of premiums for all bonds and insurance that Contractor is required by the Contract Documents to purchase and maintain.

C. *Costs Excluded*: The term Cost of the Work does not include any of the following items:

- 1. Payroll costs and other compensation of Contractor's officers, executives, principals, general managers, engineers, architects, estimators, attorneys, auditors, accountants, purchasing and contracting agents, expeditors, timekeepers, clerks, and other personnel employed by Contractor, whether at the Site or in Contractor's principal or branch office for general administration of the Work and not specifically included in the agreed upon schedule of job classifications referred to in Paragraph 13.01.B.1 or specifically covered by Paragraph 13.01.B.4. The payroll costs and other compensation excluded here are to be considered administrative costs covered by the Contractor's fee.
- 2. The cost of purchasing, renting, or furnishing small tools and hand tools.
- 3. Expenses of Contractor's principal and branch offices other than Contractor's office at the Site.
- 4. Any part of Contractor's capital expenses, including interest on Contractor's capital employed for the Work and charges against Contractor for delinquent payments.
- 5. Costs due to the negligence of Contractor, any Subcontractor, or anyone directly or indirectly employed by any of them or for whose acts any of them may be liable, including but not limited to, the correction of defective Work, disposal of materials or equipment wrongly supplied, and making good any damage to property.
- 6. Expenses incurred in preparing and advancing Claims.
- 7. Other overhead or general expense costs of any kind and the costs of any item not specifically and expressly included in Paragraph 13.01.B.

D. *Contractor's Fee*

- 1. When the Work as a whole is performed on the basis of cost-plus-a-fee, then:
 - a. Contractor's fee for the Work set forth in the Contract Documents as of the Effective Date of the Contract will be determined as set forth in the Agreement.
 - b. for any Work covered by a Change Order, Change Proposal, Claim, set-off, or other adjustment in Contract Price on the basis of Cost of the Work, Contractor's fee will be determined as follows:
 - 1) When the fee for the Work as a whole is a percentage of the Cost of the Work, the fee will automatically adjust as the Cost of the Work changes.
 - 2) When the fee for the Work as a whole is a fixed fee, the fee for any additions or deletions will be determined in accordance with Paragraph 11.07.C.2.
- 2. When the Work as a whole is performed on the basis of a stipulated sum, or any other basis other than cost-plus-a-fee, then Contractor's fee for any Work covered by a Change

Order, Change Proposal, Claim, set-off, or other adjustment in Contract Price on the basis of Cost of the Work will be determined in accordance with Paragraph 11.07.C.2.

- E. *Documentation and Audit*: Whenever the Cost of the Work for any purpose is to be determined pursuant to this Article 13, Contractor and pertinent Subcontractors will establish and maintain records of the costs in accordance with generally accepted accounting practices. Subject to prior written notice, Owner will be afforded reasonable access, during normal business hours, to all Contractor's accounts, records, books, correspondence, instructions, drawings, receipts, vouchers, memoranda, and similar data relating to the Cost of the Work and Contractor's fee. Contractor shall preserve all such documents for a period of three years after the final payment by Owner. Pertinent Subcontractors will afford such access to Owner, and preserve such documents, to the same extent required of Contractor.

13.02 Allowances

- A. It is understood that Contractor has included in the Contract Price all allowances so named in the Contract Documents and shall cause the Work so covered to be performed for such sums and by such persons or entities as may be acceptable to Owner and Engineer.
- B. *Cash Allowances*: Contractor agrees that:
1. the cash allowances include the cost to Contractor (less any applicable trade discounts) of materials and equipment required by the allowances to be delivered at the Site, and all applicable taxes; and
 2. Contractor's costs for unloading and handling on the Site, labor, installation, overhead, profit, and other expenses contemplated for the cash allowances have been included in the Contract Price and not in the allowances, and no demand for additional payment for any of the foregoing will be valid.
- C. *Owner's Contingency Allowance*: Contractor agrees that an Owner's contingency allowance, if any, is for the sole use of Owner to cover unanticipated costs.
- D. Prior to final payment, an appropriate Change Order will be issued as recommended by Engineer to reflect actual amounts due Contractor for Work covered by allowances, and the Contract Price will be correspondingly adjusted.

13.03 Unit Price Work

- A. Where the Contract Documents provide that all or part of the Work is to be Unit Price Work, initially the Contract Price will be deemed to include for all Unit Price Work an amount equal to the sum of the unit price for each separately identified item of Unit Price Work times the estimated quantity of each item as indicated in the Agreement.
- B. The estimated quantities of items of Unit Price Work are not guaranteed and are solely for the purpose of comparison of Bids and determining an initial Contract Price. Payments to Contractor for Unit Price Work will be based on actual quantities.
- C. Each unit price will be deemed to include an amount considered by Contractor to be adequate to cover Contractor's overhead and profit for each separately identified item.
- D. Engineer will determine the actual quantities and classifications of Unit Price Work performed by Contractor. Engineer will review with Contractor the Engineer's preliminary determinations on such matters before rendering a written decision thereon (by recommendation of an Application for Payment or otherwise). Engineer's written decision

thereon will be final and binding (except as modified by Engineer to reflect changed factual conditions or more accurate data) upon Owner and Contractor, and the final adjustment of Contract Price will be set forth in a Change Order, subject to the provisions of the following paragraph.

E. *Adjustments in Unit Price*

1. Contractor or Owner shall be entitled to an adjustment in the unit price with respect to an item of Unit Price Work if:
 - a. the quantity of the item of Unit Price Work performed by Contractor differs materially and significantly from the estimated quantity of such item indicated in the Agreement; and
 - b. Contractor's unit costs to perform the item of Unit Price Work have changed materially and significantly as a result of the quantity change.
2. The adjustment in unit price will account for and be coordinated with any related changes in quantities of other items of Work, and in Contractor's costs to perform such other Work, such that the resulting overall change in Contract Price is equitable to Owner and Contractor.
3. Adjusted unit prices will apply to all units of that item.

ARTICLE 14—TESTS AND INSPECTIONS; CORRECTION, REMOVAL, OR ACCEPTANCE OF DEFECTIVE WORK

14.01 *Access to Work*

- A. Owner, Engineer, their consultants and other representatives and personnel of Owner, independent testing laboratories, and authorities having jurisdiction have access to the Site and the Work at reasonable times for their observation, inspection, and testing. Contractor shall provide them proper and safe conditions for such access and advise them of Contractor's safety procedures and programs so that they may comply with such procedures and programs as applicable.

14.02 *Tests, Inspections, and Approvals*

- A. Contractor shall give Engineer timely notice of readiness of the Work (or specific parts thereof) for all required inspections and tests, and shall cooperate with inspection and testing personnel to facilitate required inspections and tests.
- B. Owner shall retain and pay for the services of an independent inspector, testing laboratory, or other qualified individual or entity to perform all inspections and tests expressly required by the Contract Documents to be furnished and paid for by Owner, except that costs incurred in connection with tests or inspections of covered Work will be governed by the provisions of Paragraph 14.05.
- C. If Laws or Regulations of any public body having jurisdiction require any Work (or part thereof) specifically to be inspected, tested, or approved by an employee or other representative of such public body, Contractor shall assume full responsibility for arranging and obtaining such inspections, tests, or approvals, pay all costs in connection therewith, and furnish Engineer the required certificates of inspection or approval.

- D. Contractor shall be responsible for arranging, obtaining, and paying for all inspections and tests required:
1. by the Contract Documents, unless the Contract Documents expressly allocate responsibility for a specific inspection or test to Owner;
 2. to attain Owner's and Engineer's acceptance of materials or equipment to be incorporated in the Work;
 3. by manufacturers of equipment furnished under the Contract Documents;
 4. for testing, adjusting, and balancing of mechanical, electrical, and other equipment to be incorporated into the Work; and
 5. for acceptance of materials, mix designs, or equipment submitted for approval prior to Contractor's purchase thereof for incorporation in the Work.

Such inspections and tests will be performed by independent inspectors, testing laboratories, or other qualified individuals or entities acceptable to Owner and Engineer.

- E. If the Contract Documents require the Work (or part thereof) to be approved by Owner, Engineer, or another designated individual or entity, then Contractor shall assume full responsibility for arranging and obtaining such approvals.
- F. If any Work (or the work of others) that is to be inspected, tested, or approved is covered by Contractor without written concurrence of Engineer, Contractor shall, if requested by Engineer, uncover such Work for observation. Such uncovering will be at Contractor's expense unless Contractor had given Engineer timely notice of Contractor's intention to cover the same and Engineer had not acted with reasonable promptness in response to such notice.

14.03 *Defective Work*

- A. *Contractor's Obligation:* It is Contractor's obligation to assure that the Work is not defective.
- B. *Engineer's Authority:* Engineer has the authority to determine whether Work is defective, and to reject defective Work.
- C. *Notice of Defects:* Prompt written notice of all defective Work of which Owner or Engineer has actual knowledge will be given to Contractor.
- D. *Correction, or Removal and Replacement:* Promptly after receipt of written notice of defective Work, Contractor shall correct all such defective Work, whether or not fabricated, installed, or completed, or, if Engineer has rejected the defective Work, remove it from the Project and replace it with Work that is not defective.
- E. *Preservation of Warranties:* When correcting defective Work, Contractor shall take no action that would void or otherwise impair Owner's special warranty and guarantee, if any, on said Work.
- F. *Costs and Damages:* In addition to its correction, removal, and replacement obligations with respect to defective Work, Contractor shall pay all claims, costs, losses, and damages arising out of or relating to defective Work, including but not limited to the cost of the inspection, testing, correction, removal, replacement, or reconstruction of such defective Work, fines levied against Owner by governmental authorities because the Work is defective, and the costs of repair or replacement of work of others resulting from defective Work. Prior to final payment, if Owner and Contractor are unable to agree as to the measure of such claims, costs,

losses, and damages resulting from defective Work, then Owner may impose a reasonable set-off against payments due under Article 15.

14.04 *Acceptance of Defective Work*

- A. If, instead of requiring correction or removal and replacement of defective Work, Owner prefers to accept it, Owner may do so (subject, if such acceptance occurs prior to final payment, to Engineer's confirmation that such acceptance is in general accord with the design intent and applicable engineering principles, and will not endanger public safety). Contractor shall pay all claims, costs, losses, and damages attributable to Owner's evaluation of and determination to accept such defective Work (such costs to be approved by Engineer as to reasonableness), and for the diminished value of the Work to the extent not otherwise paid by Contractor. If any such acceptance occurs prior to final payment, the necessary revisions in the Contract Documents with respect to the Work will be incorporated in a Change Order. If the parties are unable to agree as to the decrease in the Contract Price, reflecting the diminished value of Work so accepted, then Owner may impose a reasonable set-off against payments due under Article 15. If the acceptance of defective Work occurs after final payment, Contractor shall pay an appropriate amount to Owner.

14.05 *Uncovering Work*

- A. Engineer has the authority to require additional inspection or testing of the Work, whether or not the Work is fabricated, installed, or completed.
- B. If any Work is covered contrary to the written request of Engineer, then Contractor shall, if requested by Engineer, uncover such Work for Engineer's observation, and then replace the covering, all at Contractor's expense.
- C. If Engineer considers it necessary or advisable that covered Work be observed by Engineer or inspected or tested by others, then Contractor, at Engineer's request, shall uncover, expose, or otherwise make available for observation, inspection, or testing as Engineer may require, that portion of the Work in question, and provide all necessary labor, material, and equipment.
 - 1. If it is found that the uncovered Work is defective, Contractor shall be responsible for all claims, costs, losses, and damages arising out of or relating to such uncovering, exposure, observation, inspection, and testing, and of satisfactory replacement or reconstruction (including but not limited to all costs of repair or replacement of work of others); and pending Contractor's full discharge of this responsibility the Owner shall be entitled to impose a reasonable set-off against payments due under Article 15.
 - 2. If the uncovered Work is not found to be defective, Contractor shall be allowed an increase in the Contract Price or an extension of the Contract Times, directly attributable to such uncovering, exposure, observation, inspection, testing, replacement, and reconstruction. If the parties are unable to agree as to the amount or extent thereof, then Contractor may submit a Change Proposal within 30 days of the determination that the Work is not defective.

14.06 *Owner May Stop the Work*

- A. If the Work is defective, or Contractor fails to supply sufficient skilled workers or suitable materials or equipment, or fails to perform the Work in such a way that the completed Work will conform to the Contract Documents, then Owner may order Contractor to stop the Work,

or any portion thereof, until the cause for such order has been eliminated; however, this right of Owner to stop the Work will not give rise to any duty on the part of Owner to exercise this right for the benefit of Contractor, any Subcontractor, any Supplier, any other individual or entity, or any surety for, or employee or agent of any of them.

14.07 Owner May Correct Defective Work

- A. If Contractor fails within a reasonable time after written notice from Engineer to correct defective Work, or to remove and replace defective Work as required by Engineer, then Owner may, after 7 days' written notice to Contractor, correct or remedy any such deficiency.
- B. In exercising the rights and remedies under this Paragraph 14.07, Owner shall proceed expeditiously. In connection with such corrective or remedial action, Owner may exclude Contractor from all or part of the Site, take possession of all or part of the Work and suspend Contractor's services related thereto, and incorporate in the Work all materials and equipment stored at the Site or for which Owner has paid Contractor but which are stored elsewhere. Contractor shall allow Owner, Owner's representatives, agents and employees, Owner's other contractors, and Engineer and Engineer's consultants access to the Site to enable Owner to exercise the rights and remedies under this paragraph.
- C. All claims, costs, losses, and damages incurred or sustained by Owner in exercising the rights and remedies under this Paragraph 14.07 will be charged against Contractor as set-offs against payments due under Article 15. Such claims, costs, losses and damages will include but not be limited to all costs of repair, or replacement of work of others destroyed or damaged by correction, removal, or replacement of Contractor's defective Work.
- D. Contractor shall not be allowed an extension of the Contract Times because of any delay in the performance of the Work attributable to the exercise by Owner of Owner's rights and remedies under this Paragraph 14.07.

ARTICLE 15—PAYMENTS TO CONTRACTOR; SET-OFFS; COMPLETION; CORRECTION PERIOD

15.01 Progress Payments

- A. *Basis for Progress Payments:* The Schedule of Values established as provided in Article 2 will serve as the basis for progress payments and will be incorporated into a form of Application for Payment acceptable to Engineer. Progress payments for Unit Price Work will be based on the number of units completed during the pay period, as determined under the provisions of Paragraph 13.03. Progress payments for cost-based Work will be based on Cost of the Work completed by Contractor during the pay period.
- B. *Applications for Payments*
 - 1. At least 20 days before the date established in the Agreement for each progress payment (but not more often than once a month), Contractor shall submit to Engineer for review an Application for Payment filled out and signed by Contractor covering the Work completed as of the date of the Application and accompanied by such supporting documentation as is required by the Contract Documents.
 - 2. If payment is requested on the basis of materials and equipment not incorporated in the Work but delivered and suitably stored at the Site or at another location agreed to in writing, the Application for Payment must also be accompanied by: (a) a bill of sale, invoice, copies of subcontract or purchase order payments, or other documentation

establishing full payment by Contractor for the materials and equipment; (b) at Owner's request, documentation warranting that Owner has received the materials and equipment free and clear of all Liens; and (c) evidence that the materials and equipment are covered by appropriate property insurance, a warehouse bond, or other arrangements to protect Owner's interest therein, all of which must be satisfactory to Owner.

3. Beginning with the second Application for Payment, each Application must include an affidavit of Contractor stating that all previous progress payments received by Contractor have been applied to discharge Contractor's legitimate obligations associated with prior Applications for Payment.
4. The amount of retainage with respect to progress payments will be as stipulated in the Agreement.

C. *Review of Applications*

1. Engineer will, within 10 days after receipt of each Application for Payment, including each resubmittal, either indicate in writing a recommendation of payment and present the Application to Owner, or return the Application to Contractor indicating in writing Engineer's reasons for refusing to recommend payment. In the latter case, Contractor may make the necessary corrections and resubmit the Application.
2. Engineer's recommendation of any payment requested in an Application for Payment will constitute a representation by Engineer to Owner, based on Engineer's observations of the executed Work as an experienced and qualified design professional, and on Engineer's review of the Application for Payment and the accompanying data and schedules, that to the best of Engineer's knowledge, information and belief:
 - a. the Work has progressed to the point indicated;
 - b. the quality of the Work is generally in accordance with the Contract Documents (subject to an evaluation of the Work as a functioning whole prior to or upon Substantial Completion, the results of any subsequent tests called for in the Contract Documents, a final determination of quantities and classifications for Unit Price Work under Paragraph 13.03, and any other qualifications stated in the recommendation); and
 - c. the conditions precedent to Contractor's being entitled to such payment appear to have been fulfilled in so far as it is Engineer's responsibility to observe the Work.
3. By recommending any such payment Engineer will not thereby be deemed to have represented that:
 - a. inspections made to check the quality or the quantity of the Work as it has been performed have been exhaustive, extended to every aspect of the Work in progress, or involved detailed inspections of the Work beyond the responsibilities specifically assigned to Engineer in the Contract; or
 - b. there may not be other matters or issues between the parties that might entitle Contractor to be paid additionally by Owner or entitle Owner to withhold payment to Contractor.

4. Neither Engineer's review of Contractor's Work for the purposes of recommending payments nor Engineer's recommendation of any payment, including final payment, will impose responsibility on Engineer:
 - a. to supervise, direct, or control the Work;
 - b. for the means, methods, techniques, sequences, or procedures of construction, or the safety precautions and programs incident thereto;
 - c. for Contractor's failure to comply with Laws and Regulations applicable to Contractor's performance of the Work;
 - d. to make any examination to ascertain how or for what purposes Contractor has used the money paid by Owner; or
 - e. to determine that title to any of the Work, materials, or equipment has passed to Owner free and clear of any Liens.
5. Engineer may refuse to recommend the whole or any part of any payment if, in Engineer's opinion, it would be incorrect to make the representations to Owner stated in Paragraph 15.01.C.2.
6. Engineer will recommend reductions in payment (set-offs) necessary in Engineer's opinion to protect Owner from loss because:
 - a. the Work is defective, requiring correction or replacement;
 - b. the Contract Price has been reduced by Change Orders;
 - c. Owner has been required to correct defective Work in accordance with Paragraph 14.07, or has accepted defective Work pursuant to Paragraph 14.04;
 - d. Owner has been required to remove or remediate a Hazardous Environmental Condition for which Contractor is responsible; or
 - e. Engineer has actual knowledge of the occurrence of any of the events that would constitute a default by Contractor and therefore justify termination for cause under the Contract Documents.

D. *Payment Becomes Due*

1. Ten days after presentation of the Application for Payment to Owner with Engineer's recommendation, the amount recommended (subject to any Owner set-offs) will become due, and when due will be paid by Owner to Contractor.

E. *Reductions in Payment by Owner*

1. In addition to any reductions in payment (set-offs) recommended by Engineer, Owner is entitled to impose a set-off against payment based on any of the following:
 - a. Claims have been made against Owner based on Contractor's conduct in the performance or furnishing of the Work, or Owner has incurred costs, losses, or damages resulting from Contractor's conduct in the performance or furnishing of the Work, including but not limited to claims, costs, losses, or damages from workplace injuries, adjacent property damage, non-compliance with Laws and Regulations, and patent infringement;

- b. Contractor has failed to take reasonable and customary measures to avoid damage, delay, disruption, and interference with other work at or adjacent to the Site;
 - c. Contractor has failed to provide and maintain required bonds or insurance;
 - d. Owner has been required to remove or remediate a Hazardous Environmental Condition for which Contractor is responsible;
 - e. Owner has incurred extra charges or engineering costs related to submittal reviews, evaluations of proposed substitutes, tests and inspections, or return visits to manufacturing or assembly facilities;
 - f. The Work is defective, requiring correction or replacement;
 - g. Owner has been required to correct defective Work in accordance with Paragraph 14.07, or has accepted defective Work pursuant to Paragraph 14.04;
 - h. The Contract Price has been reduced by Change Orders;
 - i. An event has occurred that would constitute a default by Contractor and therefore justify a termination for cause;
 - j. Liquidated or other damages have accrued as a result of Contractor's failure to achieve Milestones, Substantial Completion, or final completion of the Work;
 - k. Liens have been filed in connection with the Work, except where Contractor has delivered a specific bond satisfactory to Owner to secure the satisfaction and discharge of such Liens; or
 - l. Other items entitle Owner to a set-off against the amount recommended.
2. If Owner imposes any set-off against payment, whether based on its own knowledge or on the written recommendations of Engineer, Owner will give Contractor immediate written notice (with a copy to Engineer) stating the reasons for such action and the specific amount of the reduction, and promptly pay Contractor any amount remaining after deduction of the amount so withheld. Owner shall promptly pay Contractor the amount so withheld, or any adjustment thereto agreed to by Owner and Contractor, if Contractor remedies the reasons for such action. The reduction imposed will be binding on Contractor unless it duly submits a Change Proposal contesting the reduction.
 3. Upon a subsequent determination that Owner's refusal of payment was not justified, the amount wrongfully withheld will be treated as an amount due as determined by Paragraph 15.01.D.1 and subject to interest as provided in the Agreement.

15.02 Contractor's Warranty of Title

- A. Contractor warrants and guarantees that title to all Work, materials, and equipment furnished under the Contract will pass to Owner free and clear of (1) all Liens and other title defects, and (2) all patent, licensing, copyright, or royalty obligations, no later than 7 days after the time of payment by Owner.

15.03 Substantial Completion

- A. When Contractor considers the entire Work ready for its intended use Contractor shall notify Owner and Engineer in writing that the entire Work is substantially complete and request that Engineer issue a certificate of Substantial Completion. Contractor shall at the same time

submit to Owner and Engineer an initial draft of punch list items to be completed or corrected before final payment.

- B. Promptly after Contractor's notification, Owner, Contractor, and Engineer shall make an inspection of the Work to determine the status of completion. If Engineer does not consider the Work substantially complete, Engineer will notify Contractor in writing giving the reasons therefor.
- C. If Engineer considers the Work substantially complete, Engineer will deliver to Owner a preliminary certificate of Substantial Completion which will fix the date of Substantial Completion. Engineer shall attach to the certificate a punch list of items to be completed or corrected before final payment. Owner shall have 7 days after receipt of the preliminary certificate during which to make written objection to Engineer as to any provisions of the certificate or attached punch list. If, after considering the objections to the provisions of the preliminary certificate, Engineer concludes that the Work is not substantially complete, Engineer will, within 14 days after submission of the preliminary certificate to Owner, notify Contractor in writing that the Work is not substantially complete, stating the reasons therefor. If Owner does not object to the provisions of the certificate, or if despite consideration of Owner's objections Engineer concludes that the Work is substantially complete, then Engineer will, within said 14 days, execute and deliver to Owner and Contractor a final certificate of Substantial Completion (with a revised punch list of items to be completed or corrected) reflecting such changes from the preliminary certificate as Engineer believes justified after consideration of any objections from Owner.
- D. At the time of receipt of the preliminary certificate of Substantial Completion, Owner and Contractor will confer regarding Owner's use or occupancy of the Work following Substantial Completion, review the builder's risk insurance policy with respect to the end of the builder's risk coverage, and confirm the transition to coverage of the Work under a permanent property insurance policy held by Owner. Unless Owner and Contractor agree otherwise in writing, Owner shall bear responsibility for security, operation, protection of the Work, property insurance, maintenance, heat, and utilities upon Owner's use or occupancy of the Work.
- E. After Substantial Completion the Contractor shall promptly begin work on the punch list of items to be completed or corrected prior to final payment. In appropriate cases Contractor may submit monthly Applications for Payment for completed punch list items, following the progress payment procedures set forth above.
- F. Owner shall have the right to exclude Contractor from the Site after the date of Substantial Completion subject to allowing Contractor reasonable access to remove its property and complete or correct items on the punch list.

15.04 *Partial Use or Occupancy*

- A. Prior to Substantial Completion of all the Work, Owner may use or occupy any substantially completed part of the Work which has specifically been identified in the Contract Documents, or which Owner, Engineer, and Contractor agree constitutes a separately functioning and usable part of the Work that can be used by Owner for its intended purpose without

significant interference with Contractor's performance of the remainder of the Work, subject to the following conditions:

1. At any time, Owner may request in writing that Contractor permit Owner to use or occupy any such part of the Work that Owner believes to be substantially complete. If and when Contractor agrees that such part of the Work is substantially complete, Contractor, Owner, and Engineer will follow the procedures of Paragraph 15.03.A through 15.03.E for that part of the Work.
2. At any time, Contractor may notify Owner and Engineer in writing that Contractor considers any such part of the Work substantially complete and request Engineer to issue a certificate of Substantial Completion for that part of the Work.
3. Within a reasonable time after either such request, Owner, Contractor, and Engineer shall make an inspection of that part of the Work to determine its status of completion. If Engineer does not consider that part of the Work to be substantially complete, Engineer will notify Owner and Contractor in writing giving the reasons therefor. If Engineer considers that part of the Work to be substantially complete, the provisions of Paragraph 15.03 will apply with respect to certification of Substantial Completion of that part of the Work and the division of responsibility in respect thereof and access thereto.
4. No use or occupancy or separate operation of part of the Work may occur prior to compliance with the requirements of Paragraph 6.04 regarding builder's risk or other property insurance.

15.05 *Final Inspection*

- A. Upon written notice from Contractor that the entire Work or an agreed portion thereof is complete, Engineer will promptly make a final inspection with Owner and Contractor and will notify Contractor in writing of all particulars in which this inspection reveals that the Work, or agreed portion thereof, is incomplete or defective. Contractor shall immediately take such measures as are necessary to complete such Work or remedy such deficiencies.

15.06 *Final Payment*

A. *Application for Payment*

1. After Contractor has, in the opinion of Engineer, satisfactorily completed all corrections identified during the final inspection and has delivered, in accordance with the Contract Documents, all maintenance and operating instructions, schedules, guarantees, bonds, certificates or other evidence of insurance, certificates of inspection, annotated record documents (as provided in Paragraph 7.12), and other documents, Contractor may make application for final payment.
2. The final Application for Payment must be accompanied (except as previously delivered) by:
 - a. all documentation called for in the Contract Documents;
 - b. consent of the surety, if any, to final payment;
 - c. satisfactory evidence that all title issues have been resolved such that title to all Work, materials, and equipment has passed to Owner free and clear of any Liens or other title defects, or will so pass upon final payment.

- d. a list of all duly pending Change Proposals and Claims; and
 - e. complete and legally effective releases or waivers (satisfactory to Owner) of all Lien rights arising out of the Work, and of Liens filed in connection with the Work.
3. In lieu of the releases or waivers of Liens specified in Paragraph 15.06.A.2 and as approved by Owner, Contractor may furnish receipts or releases in full and an affidavit of Contractor that: (a) the releases and receipts include all labor, services, material, and equipment for which a Lien could be filed; and (b) all payrolls, material and equipment bills, and other indebtedness connected with the Work for which Owner might in any way be responsible, or which might in any way result in liens or other burdens on Owner's property, have been paid or otherwise satisfied. If any Subcontractor or Supplier fails to furnish such a release or receipt in full, Contractor may furnish a bond or other collateral satisfactory to Owner to indemnify Owner against any Lien, or Owner at its option may issue joint checks payable to Contractor and specified Subcontractors and Suppliers.
- B. *Engineer's Review of Final Application and Recommendation of Payment:* If, on the basis of Engineer's observation of the Work during construction and final inspection, and Engineer's review of the final Application for Payment and accompanying documentation as required by the Contract Documents, Engineer is satisfied that the Work has been completed and Contractor's other obligations under the Contract have been fulfilled, Engineer will, within 10 days after receipt of the final Application for Payment, indicate in writing Engineer's recommendation of final payment and present the final Application for Payment to Owner for payment. Such recommendation will account for any set-offs against payment that are necessary in Engineer's opinion to protect Owner from loss for the reasons stated above with respect to progress payments. Otherwise, Engineer will return the Application for Payment to Contractor, indicating in writing the reasons for refusing to recommend final payment, in which case Contractor shall make the necessary corrections and resubmit the Application for Payment.
- C. *Notice of Acceptability:* In support of its recommendation of payment of the final Application for Payment, Engineer will also give written notice to Owner and Contractor that the Work is acceptable, subject to stated limitations in the notice and to the provisions of Paragraph 15.07.
- D. *Completion of Work:* The Work is complete (subject to surviving obligations) when it is ready for final payment as established by the Engineer's written recommendation of final payment and issuance of notice of the acceptability of the Work.
- E. *Final Payment Becomes Due:* Upon receipt from Engineer of the final Application for Payment and accompanying documentation, Owner shall set off against the amount recommended by Engineer for final payment any further sum to which Owner is entitled, including but not limited to set-offs for liquidated damages and set-offs allowed under the provisions of this Contract with respect to progress payments. Owner shall pay the resulting balance due to Contractor within 30 days of Owner's receipt of the final Application for Payment from Engineer.

15.07 *Waiver of Claims*

- A. By making final payment, Owner waives its claim or right to liquidated damages or other damages for late completion by Contractor, except as set forth in an outstanding Claim,

appeal under the provisions of Article 17, set-off, or express reservation of rights by Owner. Owner reserves all other claims or rights after final payment.

- B. The acceptance of final payment by Contractor will constitute a waiver by Contractor of all claims and rights against Owner other than those pending matters that have been duly submitted as a Claim, or appealed under the provisions of Article 17.

15.08 *Correction Period*

- A. If within one year after the date of Substantial Completion (or such longer period of time as may be prescribed by the Supplementary Conditions or the terms of any applicable special guarantee required by the Contract Documents), Owner gives Contractor written notice that any Work has been found to be defective, or that Contractor's repair of any damages to the Site or adjacent areas has been found to be defective, then after receipt of such notice of defect Contractor shall promptly, without cost to Owner and in accordance with Owner's written instructions:
 - 1. correct the defective repairs to the Site or such adjacent areas;
 - 2. correct such defective Work;
 - 3. remove the defective Work from the Project and replace it with Work that is not defective, if the defective Work has been rejected by Owner, and
 - 4. satisfactorily correct or repair or remove and replace any damage to other Work, to the work of others, or to other land or areas resulting from the corrective measures.
- B. Owner shall give any such notice of defect within 60 days of the discovery that such Work or repairs is defective. If such notice is given within such 60 days but after the end of the correction period, the notice will be deemed a notice of defective Work under Paragraph 7.17.B.
- C. If, after receipt of a notice of defect within 60 days and within the correction period, Contractor does not promptly comply with the terms of Owner's written instructions, or in an emergency where delay would cause serious risk of loss or damage, Owner may have the defective Work corrected or repaired or may have the rejected Work removed and replaced. Contractor shall pay all costs, losses, and damages (including but not limited to all fees and charges of engineers, architects, attorneys, and other professionals and all court or arbitration or other dispute resolution costs) arising out of or relating to such correction or repair or such removal and replacement (including but not limited to all costs of repair or replacement of work of others). Contractor's failure to pay such costs, losses, and damages within 10 days of invoice from Owner will be deemed the start of an event giving rise to a Claim under Paragraph 12.01.B, such that any related Claim must be brought within 30 days of the failure to pay.
- D. In special circumstances where a particular item of equipment is placed in continuous service before Substantial Completion of all the Work, the correction period for that item may start to run from an earlier date if so provided in the Specifications.
- E. Where defective Work (and damage to other Work resulting therefrom) has been corrected or removed and replaced under this paragraph, the correction period hereunder with respect to such Work will be extended for an additional period of one year after such correction or removal and replacement has been satisfactorily completed.

- F. Contractor's obligations under this paragraph are in addition to all other obligations and warranties. The provisions of this paragraph are not to be construed as a substitute for, or a waiver of, the provisions of any applicable statute of limitation or repose.

ARTICLE 16—SUSPENSION OF WORK AND TERMINATION

16.01 *Owner May Suspend Work*

- A. At any time and without cause, Owner may suspend the Work or any portion thereof for a period of not more than 90 consecutive days by written notice to Contractor and Engineer. Such notice will fix the date on which Work will be resumed. Contractor shall resume the Work on the date so fixed. Contractor shall be entitled to an adjustment in the Contract Price or an extension of the Contract Times directly attributable to any such suspension. Any Change Proposal seeking such adjustments must be submitted no later than 30 days after the date fixed for resumption of Work.

16.02 *Owner May Terminate for Cause*

- A. The occurrence of any one or more of the following events will constitute a default by Contractor and justify termination for cause:
 - 1. Contractor's persistent failure to perform the Work in accordance with the Contract Documents (including, but not limited to, failure to supply sufficient skilled workers or suitable materials or equipment, or failure to adhere to the Progress Schedule);
 - 2. Failure of Contractor to perform or otherwise to comply with a material term of the Contract Documents;
 - 3. Contractor's disregard of Laws or Regulations of any public body having jurisdiction; or
 - 4. Contractor's repeated disregard of the authority of Owner or Engineer.
- B. If one or more of the events identified in Paragraph 16.02.A occurs, then after giving Contractor (and any surety) 10 days' written notice that Owner is considering a declaration that Contractor is in default and termination of the Contract, Owner may proceed to:
 - 1. declare Contractor to be in default, and give Contractor (and any surety) written notice that the Contract is terminated; and
 - 2. enforce the rights available to Owner under any applicable performance bond.
- C. Subject to the terms and operation of any applicable performance bond, if Owner has terminated the Contract for cause, Owner may exclude Contractor from the Site, take possession of the Work, incorporate in the Work all materials and equipment stored at the Site or for which Owner has paid Contractor but which are stored elsewhere, and complete the Work as Owner may deem expedient.
- D. Owner may not proceed with termination of the Contract under Paragraph 16.02.B if Contractor within 7 days of receipt of notice of intent to terminate begins to correct its failure to perform and proceeds diligently to cure such failure.
- E. If Owner proceeds as provided in Paragraph 16.02.B, Contractor shall not be entitled to receive any further payment until the Work is completed. If the unpaid balance of the Contract Price exceeds the cost to complete the Work, including all related claims, costs, losses, and damages (including but not limited to all fees and charges of engineers, architects,

attorneys, and other professionals) sustained by Owner, such excess will be paid to Contractor. If the cost to complete the Work including such related claims, costs, losses, and damages exceeds such unpaid balance, Contractor shall pay the difference to Owner. Such claims, costs, losses, and damages incurred by Owner will be reviewed by Engineer as to their reasonableness and, when so approved by Engineer, incorporated in a Change Order. When exercising any rights or remedies under this paragraph, Owner shall not be required to obtain the lowest price for the Work performed.

- F. Where Contractor's services have been so terminated by Owner, the termination will not affect any rights or remedies of Owner against Contractor then existing or which may thereafter accrue, or any rights or remedies of Owner against Contractor or any surety under any payment bond or performance bond. Any retention or payment of money due Contractor by Owner will not release Contractor from liability.
- G. If and to the extent that Contractor has provided a performance bond under the provisions of Paragraph 6.01.A, the provisions of that bond will govern over any inconsistent provisions of Paragraphs 16.02.B and 16.02.D.

16.03 *Owner May Terminate for Convenience*

- A. Upon 7 days' written notice to Contractor and Engineer, Owner may, without cause and without prejudice to any other right or remedy of Owner, terminate the Contract. In such case, Contractor shall be paid for (without duplication of any items):
 - 1. completed and acceptable Work executed in accordance with the Contract Documents prior to the effective date of termination, including fair and reasonable sums for overhead and profit on such Work;
 - 2. expenses sustained prior to the effective date of termination in performing services and furnishing labor, materials, or equipment as required by the Contract Documents in connection with uncompleted Work, plus fair and reasonable sums for overhead and profit on such expenses; and
 - 3. other reasonable expenses directly attributable to termination, including costs incurred to prepare a termination for convenience cost proposal.
- B. Contractor shall not be paid for any loss of anticipated profits or revenue, post-termination overhead costs, or other economic loss arising out of or resulting from such termination.

16.04 *Contractor May Stop Work or Terminate*

- A. If, through no act or fault of Contractor, (1) the Work is suspended for more than 90 consecutive days by Owner or under an order of court or other public authority, or (2) Engineer fails to act on any Application for Payment within 30 days after it is submitted, or (3) Owner fails for 30 days to pay Contractor any sum finally determined to be due, then Contractor may, upon 7 days' written notice to Owner and Engineer, and provided Owner or Engineer do not remedy such suspension or failure within that time, terminate the contract and recover from Owner payment on the same terms as provided in Paragraph 16.03.
- B. In lieu of terminating the Contract and without prejudice to any other right or remedy, if Engineer has failed to act on an Application for Payment within 30 days after it is submitted, or Owner has failed for 30 days to pay Contractor any sum finally determined to be due, Contractor may, 7 days after written notice to Owner and Engineer, stop the Work until payment is made of all such amounts due Contractor, including interest thereon. The

provisions of this paragraph are not intended to preclude Contractor from submitting a Change Proposal for an adjustment in Contract Price or Contract Times or otherwise for expenses or damage directly attributable to Contractor's stopping the Work as permitted by this paragraph.

ARTICLE 17—FINAL RESOLUTION OF DISPUTES

17.01 *Methods and Procedures*

- A. *Disputes Subject to Final Resolution:* The following disputed matters are subject to final resolution under the provisions of this article:
1. A timely appeal of an approval in part and denial in part of a Claim, or of a denial in full, pursuant to Article 12; and
 2. Disputes between Owner and Contractor concerning the Work, or obligations under the Contract Documents, that arise after final payment has been made.
- B. *Final Resolution of Disputes:* For any dispute subject to resolution under this article, Owner or Contractor may:
1. elect in writing to invoke the dispute resolution process provided for in the Supplementary Conditions;
 2. agree with the other party to submit the dispute to another dispute resolution process; or
 3. if no dispute resolution process is provided for in the Supplementary Conditions or mutually agreed to, give written notice to the other party of the intent to submit the dispute to a court of competent jurisdiction.

ARTICLE 18—MISCELLANEOUS

18.01 *Giving Notice*

- A. Whenever any provision of the Contract requires the giving of written notice to Owner, Engineer, or Contractor, it will be deemed to have been validly given only if delivered:
1. in person, by a commercial courier service or otherwise, to the recipient's place of business;
 2. by registered or certified mail, postage prepaid, to the recipient's place of business; or
 3. by e-mail to the recipient, with the words "Formal Notice" or similar in the e-mail's subject line.

18.02 *Computation of Times*

- A. When any period of time is referred to in the Contract by days, it will be computed to exclude the first and include the last day of such period. If the last day of any such period falls on a Saturday or Sunday or on a day made a legal holiday by the law of the applicable jurisdiction, such day will be omitted from the computation.

18.03 *Cumulative Remedies*

- A. The duties and obligations imposed by these General Conditions and the rights and remedies available hereunder to the parties hereto are in addition to, and are not to be construed in any way as a limitation of, any rights and remedies available to any or all of them which are otherwise imposed or available by Laws or Regulations, by special warranty or guarantee, or by other provisions of the Contract. The provisions of this paragraph will be as effective as if repeated specifically in the Contract Documents in connection with each particular duty, obligation, right, and remedy to which they apply.

18.04 *Limitation of Damages*

- A. With respect to any and all Change Proposals, Claims, disputes subject to final resolution, and other matters at issue, neither Owner nor Engineer, nor any of their officers, directors, members, partners, employees, agents, consultants, or subcontractors, shall be liable to Contractor for any claims, costs, losses, or damages sustained by Contractor on or in connection with any other project or anticipated project.

18.05 *No Waiver*

- A. A party's non-enforcement of any provision will not constitute a waiver of that provision, nor will it affect the enforceability of that provision or of the remainder of this Contract.

18.06 *Survival of Obligations*

- A. All representations, indemnifications, warranties, and guarantees made in, required by, or given in accordance with the Contract, as well as all continuing obligations indicated in the Contract, will survive final payment, completion, and acceptance of the Work or termination of the Contract or of the services of Contractor.

18.07 *Controlling Law*

- A. This Contract is to be governed by the law of the state in which the Project is located.

18.08 *Assignment of Contract*

- A. Unless expressly agreed to elsewhere in the Contract, no assignment by a party to this Contract of any rights under or interests in the Contract will be binding on the other party without the written consent of the party sought to be bound; and, specifically but without limitation, money that may become due and money that is due may not be assigned without such consent (except to the extent that the effect of this restriction may be limited by law), and unless specifically stated to the contrary in any written consent to an assignment, no assignment will release or discharge the assignor from any duty or responsibility under the Contract.

18.09 *Successors and Assigns*

- A. Owner and Contractor each binds itself, its successors, assigns, and legal representatives to the other party hereto, its successors, assigns, and legal representatives in respect to all covenants, agreements, and obligations contained in the Contract Documents.

18.10 *Headings*

- A. Article and paragraph headings are inserted for convenience only and do not constitute parts of these General Conditions.

This page intentionally left blank

SUPPLEMENTARY CONDITIONS OF THE CONSTRUCTION CONTRACT

TABLE OF CONTENTS

	Page
Article 1— Definitions and Terminology.....	1
Article 2— Preliminary Matters	1
Article 3— Contract Documents: Intent, Requirements, Reuse	5
Article 4— Commencement and Progress of the Work	6
Article 5— Site, Subsurface and Physical Conditions, Hazardous Environmental Conditions.....	6
Article 6— Bonds and Insurance	9
Article 7— Contractor’s Responsibilities	14
Article 8— Other Work at the Site	16
Article 9— Owner’s Responsibilities	16
Article 10— Engineer’s Status During Construction	16
Article 11— Changes to the Contract	18
Article 12— Claims	18
Article 13— Cost of Work; Allowances, Unit Price Work.....	19
Article 14— Tests and Inspections; Correction, Removal, or Acceptance of Defective Work.....	20
Article 15— Payments to Contractor, Set Offs; Completions; Correction Period	20
Article 16— Suspension of Work and Termination	21
Article 17— Final Resolutions of Disputes	21
Article 18— Miscellaneous	22
Exhibit A— Software Requirements for Electronic Document Exchange.....	1

SUPPLEMENTARY CONDITIONS OF THE CONSTRUCTION CONTRACT

These Supplementary Conditions amend or supplement EJCDC® C-700, Standard General Conditions of the Construction Contract (2018). The General Conditions remain in full force and effect except as amended.

The terms used in these Supplementary Conditions have the meanings stated in the General Conditions. Additional terms used in these Supplementary Conditions have the meanings stated below, which are applicable to both the singular and plural thereof.

The address system used in these Supplementary Conditions is the same as the address system used in the General Conditions, with the prefix "SC" added—for example, "Paragraph SC-4.05."

ARTICLE 1—DEFINITIONS AND TERMINOLOGY

1.01 *Defined Terms*

SC-1.01A Add the following new language at the end of the last sentence of Paragraph 1.01.A.50:

Work Change Directives cannot change Contract Price or Contract Times without a subsequent Change Order.

SC-1.01A Add the following new Paragraph after Paragraph 1.01.A.50

51. Abnormal Weather Conditions – Conditions of extreme or unusual weather for a given region, elevation, or season as determined by Engineer. Extreme or unusual weather that is typical for a given region, elevation, or season should not be considered Abnormal Weather Conditions.

1.02 *Terminology*

SC-1.02 Amend Paragraph 1.02.A at the end of the paragraph to add the following language:

Other terms used repeatedly in the Supplementary Conditions may be referenced in Paragraph 1.02.

SC-1.02 Amend Paragraph 1.02.C at the end of the paragraph to add the following language:

Note that Paragraph 1.02.C provides that the word "day" means a calendar day. An intended or inadvertent change to "working" day has ramifications throughout the documents and is not intended as a substitute for calendar days unless specifically agreed to, in writing, by the Owner.

ARTICLE 2—PRELIMINARY MATTERS

2.01 *Delivery of Bonds and Evidence of Insurance*

SC-2.01 Delete Paragraphs 2.01.B. and C. in their entirety and insert the following in their place:

- B. *Evidence of Contractor's Insurance:* When Contractor delivers the signed counterparts of the Agreement to Owner, Contractor shall also deliver to Owner copies of the policies (including all endorsements, and identification of applicable self-insured retentions and deductibles) of insurance required to be provided by Contractor in this Contract. Contractor may block out

(redact) any confidential premium or pricing information contained in any policy or endorsement furnished under this provision.

- C. *Evidence of Owner's Insurance:* After receipt from Contractor of the signed counterparts of the Agreement and all required bonds and insurance documentation, Owner shall promptly deliver to Contractor copies of the policies of insurance to be provided by Owner in this Contract (if any). Owner may block out (redact) any confidential premium or pricing information contained in any policy or endorsement furnished under this provision.

2.02 *Copies of Documents*

SC-2.02 Delete Paragraph 2.02.A in its entirety and insert the following new paragraph in its place:

- A. Owner shall furnish to Contractor on electronic portable document (PDF) of Contract Documents (Project Manual and 11x17 Drawings) incorporating all Addenda and any amendments negotiated prior to the Effective Date of the Contract. Additional printed copies of the conformed Contract Documents will be furnished upon request at the cost of reproduction.

SC-2.02 Delete Paragraph 2.02.A in its entirety and insert the following new paragraph in its place:

- B. Owner shall maintain an electronic portable document (PDF) of the Contract, including Drawings and Specifications signed and sealed by the Engineer. Owner will make the original PDF version of the Contract available to Contractor for review. Owner may delegate the responsibilities under this provision to the Engineer.

2.03 *Before Starting Construction*

SC-2.03 Add the following information immediately after Paragraph 2.03.A.1:

4. Revise the Progress Schedule through the Project when:
- a. Owner's Representative requests.
 - b. Work progress falls 10 percent behind scheduled progress.
 - c. When time extensions are approved for changes and causes beyond Contractor's control.
 - d. When a significant reorganization of activities becomes necessary as a result of field and material supply conditions in order to meet the contract completion date of the Project.

2.04 *Preconstruction Conference; Designation of Authorized Representatives*

SC-2.04 Delete Paragraph 2.04.A in its entirety.

2.06 *Electronic Transmittals*

SC-2.06 Delete Paragraphs 2.06.B and 2.06.C in their entirety and insert the following in their place:

- B. *Electronic Documents Protocol:* The parties shall conform to the following provisions in Paragraphs 2.06.B and 2.06.C, together referred to as the Electronic Documents Protocol ("EDP" or "Protocol") for exchange of electronic transmittals.

1. *Basic Requirements*

- a. To the fullest extent practical, the parties agree to and will transmit and accept Electronic Documents in an electronic or digital format using the procedures described in this Protocol. Use of the Electronic Documents and any information contained therein is subject to the requirements of this Protocol and other provisions of the Contract.
 - b. The contents of the information in any Electronic Document will be the responsibility of the transmitting party.
 - c. Electronic Documents as exchanged by this Protocol may be used in the same manner as the printed versions of the same documents that are exchanged using non-electronic format and methods, subject to the same governing requirements, limitations, and restrictions, set forth in the Contract Documents.
 - d. Except as otherwise explicitly stated herein, the terms of this Protocol will be incorporated into any other agreement or subcontract between a party and any third party for any portion of the Work on the Project, or any Project-related services, where that third party is, either directly or indirectly, required to exchange Electronic Documents with a party or with Engineer. Nothing herein will modify the requirements of the Contract regarding communications between and among the parties and their subcontractors and consultants.
 - e. When transmitting Electronic Documents, the transmitting party makes no representations as to long term compatibility, usability, or readability of the items resulting from the receiving party's use of software application packages, operating systems, or computer hardware differing from those established in this Protocol.
 - f. Nothing herein negates any obligation 1) in the Contract to create, provide, or maintain an original printed record version of Drawings and Specifications, signed and sealed according to applicable Laws and Regulations; 2) to comply with any applicable Law or Regulation governing the signing and sealing of design documents or the signing and electronic transmission of any other documents; or 3) to comply with the notice requirements of Paragraph 18.01 of the General Conditions.
2. *System Infrastructure for Electronic Document Exchange*
- a. Each party will provide hardware, operating system(s) software, internet, e-mail, and large file transfer functions ("System Infrastructure") at its own cost and sufficient for complying with the EDP requirements. With the exception of minimum standards set forth in this EDP, and any explicit system requirements specified by attachment to this EDP, it is the obligation of each party to determine, for itself, its own System Infrastructure.
 - 1) The maximum size of an email attachment for exchange of Electronic Documents under this EDP is 10 MB. Attachments larger than that may be exchanged using large file transfer functions or physical media.
 - 2) Each Party assumes full and complete responsibility for any and all of its own costs, delays, deficiencies, and errors associated with converting, translating, updating, verifying, licensing, or otherwise enabling its System Infrastructure, including operating systems and software, for use with respect to this EDP.

- b. Each party is responsible for its own system operations, security, back-up, archiving, audits, printing resources, and other Information Technology (“IT”) for maintaining operations of its System Infrastructure during the Project, including coordination with the party’s individual(s) or entity responsible for managing its System Infrastructure and capable of addressing routine communications and other IT issues affecting the exchange of Electronic Documents.
- c. Each party will operate and maintain industry-standard, industry-accepted, ISO-standard, commercial-grade security software and systems that are intended to protect the other party from: software viruses and other malicious software like worms, trojans, adware; data breaches; loss of confidentiality; and other threats in the transmission to or storage of information from the other parties, including transmission of Electronic Documents by physical media such as CD/DVD/flash drive/hard drive. To the extent that a party maintains and operates such security software and systems, it shall not be liable to the other party for any breach of system security.
- d. In the case of disputes, conflicts, or modifications to the EDP required to address issues affecting System Infrastructure, the parties shall cooperatively resolve the issues; but, failing resolution, the Owner is authorized to make and require reasonable and necessary changes to the EDP to effectuate its original intent. If the changes cause additional cost or time to Contractor, not reasonably anticipated under the original EDP, Contractor may seek an adjustment in price or time under the appropriate process in the Contract.
- e. Each party is responsible for its own back-up and archive of documents sent and received during the term of the contract under this EDP, unless this EDP establishes a Project document archive, either as part of a mandatory Project website or other communications protocol, upon which the parties may rely for document archiving during the specified term of operation of such Project document archive. Further, each party remains solely responsible for its own post-Project back-up and archive of Project documents after the term of the Contract, or after termination of the Project document archive, if one is established, for as long as required by the Contract and as each party deems necessary for its own purposes.
- f. If a receiving party receives an obviously corrupted, damaged, or unreadable Electronic Document, the receiving party will advise the sending party of the incomplete transmission.
- g. The parties will bring any non-conforming Electronic Documents into compliance with the EDP. The parties will attempt to complete a successful transmission of the Electronic Document or use an alternative delivery method to complete the communication.

SC-2.06 Supplement Paragraph 2.06 of the General Conditions by adding the following paragraph:

D. Requests by Contractor for Electronic Documents in Other Formats

- 1. Release of any Electronic Document versions of the Project documents in formats other than those identified in the Electronic Documents Protocol (if any) or elsewhere in the Contract will be at the sole discretion of the Owner.

2. To extent determined by Owner, in its sole discretion, to be prudent and necessary, release of Electronic Documents versions of Project documents and other Project information requested by Contractor (“Request”) in formats other than those identified in the Electronic Documents Protocol (if any) or elsewhere in the Contract will be subject to the provisions of the Owner’s response to the Request, and to the following conditions to which Contractor agrees:
 - a. The content included in the Electronic Documents created by Engineer and covered by the Request was prepared by Engineer as an internal working document for Engineer’s purposes solely, and is being provided to Contractor on an “AS IS” basis without any warranties of any kind, including, but not limited to any implied warranties of fitness for any purpose. As such, Contractor is advised and acknowledges that the content may not be suitable for Contractor’s application, or may require substantial modification and independent verification by Contractor. The content may include limited resolution of models, not-to-scale schematic representations and symbols, use of notes to convey design concepts in lieu of accurate graphics, approximations, graphical simplifications, undocumented intermediate revisions, and other devices that may affect subsequent reuse.
 - b. Electronic Documents containing text, graphics, metadata, or other types of data that are provided by Engineer to Contractor under the request are only for convenience of Contractor. Any conclusion or information obtained or derived from such data will be at the Contractor’s sole risk and the Contractor waives any claims against Engineer or Owner arising from use of data in Electronic Documents covered by the Request.
 - c. Contractor shall indemnify and hold harmless Owner and Engineer and their subconsultants from all claims, damages, losses, and expenses, including attorneys’ fees and defense costs arising out of or resulting from Contractor’s use, adaptation, or distribution of any Electronic Documents provided under the Request.
 - d. Contractor agrees not to sell, copy, transfer, forward, give away or otherwise distribute this information (in source or modified file format) to any third party without the direct written authorization of Engineer, unless such distribution is specifically identified in the Request and is limited to Contractor’s subcontractors. Contractor warrants that subsequent use by Contractor’s subcontractors complies with all terms of the Contract Documents and Owner’s response to Request.
3. In the event that Owner elects to provide or directs the Engineer to provide to Contractor any Contractor-requested Electronic Document versions of Project information that is not explicitly identified in the Contract Documents as being available to Contractor, the Owner shall be reimbursed by Contractor on an hourly basis (at \$225 per hour) for any engineering costs necessary to create or otherwise prepare the data in a manner deemed appropriate by Engineer.

ARTICLE 3—CONTRACT DOCUMENTS: INTENT, REQUIREMENTS, REUSE

3.01 *Intent*

SC-3.01 Add the following new paragraph immediately after Paragraph 3.01.G:

- H. The provisions of the Instructions to Bidders and Supplementary Conditions shall take precedence over the General Conditions. In the case of conflict, ambiguity, or discrepancy between Drawings and Specifications, or otherwise within the Contract Documents, the better quality or greater quantity of Work resulting in the greater cost shall be furnished and included in the Contract Price and the matter shall be brought to the Engineer's attention for resolution.

ARTICLE 4—COMMENCEMENT AND PROGRESS OF THE WORK

4.01 Commencement of Contract Times; Notice to Proceed

SC-4.01 Delete Paragraph 4.01.A in its entirety and insert the following new paragraph in its place:

- A. The Contract Times will commence to run on the day indicated in the Notice to Proceed. A Notice to Proceed may be given at any time within 45 days after the Effective Date of the Agreement.

4.03 Reference Points

SC-4.03 Delete paragraph 4.03 in its entirety.

ARTICLE 5—SITE, SUBSURFACE AND PHYSICAL CONDITIONS, HAZARDOUS ENVIRONMENTAL CONDITIONS

5.02 Use of Site and Other Areas

SC-5.02 Add the following new paragraphs immediately after Paragraph 5.02.D:

- E. Control of Work:
 - 1. The Contractor shall execute the Work so that it will cause the least practicable interference with, and avoid prolonged interruption of or damage to, existing facilities, underground utilities, overhead utilities, and roadways. The Contractor shall obtain written approval from the Owner at least seven (7) days before performing any Work that involves either connection to existing facilities or interruption of service or existing operations. The Contractor shall perform that Work when it causes the least interference or annoyance, as determined by the Owner and Engineer.
 - 2. The Contractor shall initiate, maintain, and supervise all weather protection and local and area climatic and seasonal precipitation event programs applicable to the Work. In the event of severe weather, the Contractor shall immediately inspect the Work at the Site and take all necessary actions to ensure that public access and safety are maintained.
 - 3. The Contractor shall be responsible for: (a) performing the pumping, draining, and controlling of surface water and groundwater in a way that it will not endanger the Work or any adjacent facility or property, or interrupt, restrict, or interfere with the use of any adjacent facility or property, and (b) taking into account any dewatering operations from other Work.

4. Neither the Owner nor Engineer will accept or coordinate deliveries for the Contractor. The Contractor shall coordinate and be at the site to receive all deliveries. Materials and equipment stored on the site or right of way shall be placed as to insure minimum danger and obstruction to the traveling public or property owners.
5. The Contractor shall take whatever steps, procedures, or means required to prevent dust nuisance due to the Contractor's operations on-site, along haul routes, within stockpile areas, and within or along equipment or material staging areas. Dust control measures shall be maintained at all times to the satisfaction of the Owner and Engineer and as required by any other Political Subdivision with jurisdiction.
6. Any dumping of spoil or waste material by the Contractor shall comply with all Federal, State, and local laws and regulations. Whether public or private landfills are used, the Contractor shall pay all required dumping fees and shall furnish to the Engineer evidence of such payments."

5.03 *Subsurface and Physical Conditions*

SC-5.03 Add the following new paragraphs immediately after Paragraph 5.03.D:

- E. In the preparation of Drawings and Specifications, Engineer relied upon the following information of explorations and tests of subsurface conditions at the Site, if any. It shall be the responsibility of the Contractor to determine to Contractor's own satisfaction the location and nature of surface and subsurface obstacles and the soil and water conditions, which will be encountered during the Work. Additional test borings and other exploratory options may be made by the Contractor at Contractor's own expense. Contractor shall make arrangements for soil investigation with Owner. Reports and existing drawings are intended for reference only. Contractor shall verify existing conditions prior to Bidding.

1. The following table lists the drawings of existing physical conditions at or adjacent to the Site, including those drawings depicting existing surface and subsurface structures at or adjacent to the Site (except Underground Facilities), that contain Technical Data (if any), and specifically identifies the Technical Data upon which Contractor may rely:

Drawings Title	Date of Drawings	Technical Data
Mandan South Side Pump Station	August 2010	None
Mandan South Side Reservoir	December 2010	None
South Side Pump Station Emergency Generator	December 2015	None

- F. Select sheets from drawings itemized in SC5.03.E can be found in Attachment No. 1. The drawing sheets are included to provide reference for surface obstacles and approximate dimensions of the existing reservoir.
- G. Copies of reports and drawings itemized in SC 5.03.E, if any, that are not included with the Bidding Documents may be examined at Advanced Engineering and Environmental Services, LLC. (AE2S) in the Engineer of Record's home office location during regular business hours. These reports and drawings, if any, are not part of the Contract Documents, but the

“technical data” contained therein upon which Contractor may rely as identified and established above are incorporated therein by reference. Contractor is not entitled to rely upon other information and data utilized by Engineer and Engineer’s Consultants in the preparation of Drawings and Specifications.

5.05 *Underground Facilities*

SC-5.05 Add the following new paragraphs immediately after Paragraph 5.05.A.5:

6. contacting all affected utilities prior to construction on this Contract and making his own investigations including exploratory excavation as needed to determine the location and type of crossing or paralleling a particular utility;
7. notification to all utilities and underground service agencies a minimum of 72 hours in advance of Work scheduled or envisioned and arrange to have their respective services located. The Contractor shall obtain acceptance, in writing, from the utility regarding the preservation of their respective service during construction. The acceptance letters/forms shall be submitted monthly (at a minimum) to the Owner’s representative;
8. using extreme care when working around overhead utilities. If required, work permits from the respective utility shall be obtained by the Contractor. Should any facility, either underground or overhead, be unexpectedly encountered or damaged during construction, the Contractor shall immediately notify a representative of the company involved and take such steps as necessary for protection of the general public and his own personnel.

SC-5.05 Add the following new paragraph immediately after Paragraph 5.05.F:

- G. The right is reserved to governmental agencies and to owners of utilities to enter at any time upon any street, alley, right-of-way, or easement for the purpose of making changes in their property made necessary by the Work and for the purpose of maintaining and making repairs to their property.

5.06 *Hazardous Environmental Conditions*

SC-5.06 Add the following new paragraphs immediately after Paragraph 5.06.A.3:

4. The following table lists the reports known to Owner relating to Hazardous Environmental Conditions at or adjacent to the Site, and the Technical Data (if any) upon which Contractor may rely:

Report Title	Date of Report	Technical Data
None		

5. The following table lists the drawings known to Owner relating to Hazardous Environmental Conditions at or adjacent to the Site, and Technical Data (if any) contained in such Drawings upon which Contractor may rely:

Drawings Title	Date of Drawings	Technical Data
None		

ARTICLE 6—

ARTICLE 6—BONDS AND INSURANCE

6.01 *Performance, Payment, and Other Bonds*

SC-6.01 Delete Paragraph 6.01.A in its entirety and insert the following new paragraph in its place:

- A. Contractor shall furnish performance and payment bonds, each in an amount at least equal to the Contract Price as security for the faithful performance and payment of all of Contractor’s obligations under the Contract Documents. These bonds shall remain in effect at 100 percent of the Contract Price for one (1) full year after the date when Substantial Completion is granted or to the end of the Warranty Period, whichever is greater, except as provided otherwise by Laws or Regulations or by the Contract Documents. Contractor shall also furnish such other bonds as are required by the Contract Documents.

6.03 *Contractor’s Insurance*

SC-6.03 Supplement Paragraph 6.03 with the following provisions after Paragraph 6.03.C:

- D. *Other Additional Insureds:* As a supplement to the provisions of Paragraph 6.03.C of the General Conditions, the commercial general liability, automobile liability, umbrella or excess, pollution liability, and unmanned aerial vehicle liability policies must include as additional insureds (in addition to Owner and Engineer) the following: **None**
- E. *Workers’ Compensation and Employer’s Liability:* Contractor shall purchase and maintain workers’ compensation and employer’s liability insurance, including, as applicable, United States Longshoreman and Harbor Workers’ Compensation Act, Jones Act, stop-gap employer’s liability coverage for monopolistic states, and foreign voluntary workers’ compensation (from available sources, notwithstanding the jurisdictional requirement of Paragraph 6.02.B of the General Conditions).

Workers’ Compensation and Related Policies	Policy limits of not less than:
Workers’ Compensation	
State	Statutory
Applicable Federal (e.g., Longshoreman’s)	Statutory
Employer’s Liability	
Each accident	\$ 1,000,000
Each employee	\$ 1,000,000
Policy limit	
Stop-gap Liability Coverage	
For work performed in monopolistic states, stop-gap liability coverage must be endorsed to either the worker’s compensation or commercial general liability policy with a minimum limit of:	\$1,000,000

- F. *Commercial General Liability—Claims Covered:* Contractor shall purchase and maintain commercial general liability insurance, covering all operations by or on behalf of Contractor, on an occurrence basis, against claims for:

1. damages because of bodily injury, sickness or disease, or death of any person other than Contractor's employees,
 2. damages insured by reasonably available personal injury liability coverage, and
 3. damages because of injury to or destruction of tangible property wherever located, including loss of use resulting therefrom.
- G. *Commercial General Liability—Form and Content:* Contractor's commercial liability policy must be written on a 1996 (or later) Insurance Services Organization, Inc. (ISO) commercial general liability form (occurrence form) and include the following coverages and endorsements:
1. Products and completed operations coverage.
 - a. Such insurance must be maintained for three years after final payment.
 - b. Contractor shall furnish Owner and each other additional insured (as identified in the Supplementary Conditions or elsewhere in the Contract) evidence of continuation of such insurance at final payment and three years thereafter.
 - c. Policies shall be endorsed to provide that such insurance is primary and non-contributory to any insurance carried by the Owner.
 2. Blanket contractual liability coverage, including but not limited to coverage of Contractor's contractual indemnity obligations in Paragraph 7.18.
 3. Severability of interests and no insured-versus-insured or cross-liability exclusions.
 4. Underground, explosion, and collapse coverage.
 5. Personal injury coverage.
 6. Additional insured endorsements that include both ongoing operations and products and completed operations coverage through ISO Endorsements CG 20 10 10 01 and CG 20 37 10 01 (together). If Contractor demonstrates to Owner that the specified ISO endorsements are not commercially available, then Contractor may satisfy this requirement by providing equivalent endorsements.
 7. For design professional additional insureds, ISO Endorsement CG 20 32 07 04 "Additional Insured—Engineers, Architects or Surveyors Not Engaged by the Named Insured" or its equivalent.
- H. *Commercial General Liability—Excluded Content:* The commercial general liability insurance policy, including its coverages, endorsements, and incorporated provisions, must not include any of the following:
1. Any modification of the standard definition of "insured contract" (except to delete the railroad protective liability exclusion if Contractor is required to indemnify a railroad or others with respect to Work within 50 feet of railroad property).
 2. Any exclusion for water intrusion or water damage.
 3. Any provisions resulting in the erosion of insurance limits by defense costs other than those already incorporated in ISO form CG 00 01.
 4. Any limitation or exclusion based on the nature of Contractor's work.

I. *Commercial General Liability—Minimum Policy Limits*

Commercial General Liability	Policy limits of not less than:
General Aggregate	\$ 2,000,000
Products—Completed Operations Aggregate	\$ 1,000,000
Personal and Advertising Injury	\$ 1,000,000
Bodily Injury and Property Damage—Each Occurrence	\$ 1,000,000

- J. *Automobile Liability*: Contractor shall purchase and maintain automobile liability insurance for damages because of bodily injury or death of any person or property damage arising out of the ownership, maintenance, or use of any motor vehicle. The automobile liability policy must be written on an occurrence basis.

Automobile Liability	Policy limits of not less than:
Bodily Injury	
Each Person	\$ 1,000,000
Each Accident	\$ 1,000,000
Property Damage	
Each Accident	\$ 1,000,000
[or]	
Combined Single Limit	
Combined Single Limit (Bodily Injury and Property Damage)	\$ 2,000,000

- K. *Umbrella or Excess Liability*: Contractor shall purchase and maintain umbrella or excess liability insurance written over the underlying employer’s liability, commercial general liability, and automobile liability insurance described in the Paragraphs above. The coverage afforded must be at least as broad as that of each and every one of the underlying policies.

Excess or Umbrella Liability	Policy limits of not less than:
Each Occurrence	\$ 1,000,000
General Aggregate	\$ 1,000,000

- L. *Contractor’s Pollution Liability Insurance*: Contractor shall purchase and maintain a policy covering third-party injury and property damage, including cleanup costs, as a result of pollution conditions arising from Contractor’s operations and completed operations. This insurance must be maintained for no less than three years after final completion.

Contractor’s Pollution Liability	Policy limits of not less than:
Each Occurrence/Claim	\$ N/A
General Aggregate	\$ N/A

- M. The insurance required by the Contract Documents, through a policy or endorsement, shall include cross liability/severability of interest for all policies and endorsements.
- N. City Requirements: The Insurance coverages listed above must meeting the following additional City requirements:
 - 1. City must be endorsed on the following policies, including any excess policies, as an additional insured.
 - a. Automobile Liability
 - b. Umbrella or Excess Liability
 - 2. A “Waiver of Subrogation” waiving any right to recovery the insurance company may have against the City for the following:
 - a. General Liability
 - b. Automobile Liability
 - c. Umbrella or Excess Liability
 - d. Workers' Compensation
 - 3. Endorsements
 - a. 30 Day Notice of Cancellation for All Policies.

ARTICLE 7—CONTRACTOR’S RESPONSIBILITIES

7.03 Labor; Working Hours

SC-7.03 Add the following new subparagraphs immediately after Paragraph 7.03.C:

- 1. Regular working hours will be Monday through Friday, 7:30 AM to 7:30 PM local time.
- 2. Owner's legal holidays are all holidays recognized by the City of Mandan.

SC-7.03 Add the following new paragraph immediately after Paragraph 7.03.C:

- D. Contractor shall be responsible for the cost of any overtime pay or other expense incurred by the Owner for Engineer’s services (including those of the Resident Project Representative, if any), Owner's representative, and construction observation services, occasioned by the performance of Work on Saturday, Sunday, any legal holiday, or as overtime on any regular work day. If Contractor is responsible but does not pay, or if the parties are unable to agree as to the amount owed, then Owner may impose a reasonable set-off against payments due under Article 15.

SC-7.03 Add the following new paragraph immediately after Paragraph 7.03.D:

- E. The Contractor shall be responsible for the conduct of Contractor’s employees and employees of Subcontractors and suppliers on the Work Site. The Contractor shall take immediate steps to remedy any activity that may be construed as discriminatory, or which

creates a hostile work environment. Activities covered by this provision include, but shall not be limited to, physical contact or signs or language that is vulgar, profane, or racially or sexually derogatory.

7.05 *"Or Equals"*

SC-7.05 Add the following new subparagraph immediately after Paragraph 7.05.C:

1. "Or Equals" items of materials or equipment will be considered only during the bidding period as outlined in the Instructions to Bidders and Substitution Procedures.

7.06 *Substitutes*

SC-7.06 Add the following new subparagraph immediately after Paragraph 7.06.B:

1. Substitute items of materials or equipment will be considered only during the bidding period as outlined in the Instructions to Bidders and Substitution Procedures.

7.07 *Concerning Subcontractors and Suppliers*

SC-7.07 Amend Paragraph 7.07.D to include the following language after the last sentence:

If Owner or Engineer after due investigation, has reasonable objection to any proposed Subcontractor or Supplier, Owner may, before the Notice of Award is given, request apparent Successful Bidder to submit a substitute, in which case apparent Successful Bidder shall submit an acceptable substitute.

SC-7.07 Delete Paragraph 7.07.F in its entirety.

SC-7.07 Add the following new paragraph immediately after Paragraph 7.07.M:

- N. All Subcontractors must possess a North Dakota Contractor's License prior to beginning Work, as applicable.

7.09 *Permits*

SC-7.09 Add the following new paragraph immediately after Paragraph 7.09.A:

- A. The required permits and licenses may include, but are not limited to:
 1. Morton County Planning and Zoning – Conditional Use Permit.
 2. Morton County Planning and Zoning – Building Permit

7.12 *Record Documents*

SC-7.12 Amend Paragraph 7.12.A to include the following language after the last sentence:

If the requirements of this Paragraph 7.12.A have not been satisfied, Engineer may negate all or part of a progress payment until compliance is reached.

7.13 *Safety and Protection*

SC-7.13 Add a new paragraph immediately after Paragraph 7.13.J:

- K. Contractor agrees to promptly notify Owner of all potential Claims which arise from or result from this agreement. Contractor further agrees to take all reasonable steps to preserve all physical evidence and information which may be relevant to the circumstances surrounding

a potential claim, while maintaining public safety, and to grant to the Owner the opportunity to review and inspect such evidence, including the scene of the accident.

ARTICLE 8—OTHER WORK AT THE SITE

None.

ARTICLE 9—OWNER’S RESPONSIBILITIES

9.13 Owner’s Site Representative

SC-9.13 Add the following new paragraph immediately after Paragraph 9.12 of the General Conditions:

9.13 Owner’s Site Representative

- A. Owner will furnish an “Owner’s Site Representative” to represent Owner at the Site and assist Owner in observing the progress and quality of the Work. The Owner’s Site Representative is not Engineer’s consultant, agent, or employee. Owner’s Site Representative will be identified by the Owner at the Preconstruction Meeting. The authority and responsibilities of Owner’s Site Representative will be identified at the Preconstruction Meeting, if any.

ARTICLE 10—ENGINEER’S STATUS DURING CONSTRUCTION

10.03 Resident Project Representative

SC-10.03 Add the following new paragraphs immediately after Paragraph 10.03.B:

- C. The Resident Project Representative (RPR) will be Engineer's representative at the Site. RPR's dealings in matters pertaining to the Work in general will be with Engineer and Contractor. RPR's dealings with Subcontractors will only be through or with the full knowledge or approval of Contractor. The RPR will:
 - 1. *Conferences and Meetings:* Attend meetings with Contractor, such as preconstruction conferences, progress meetings, job conferences, and other Project-related meetings (but not including Contractor’s safety meetings), and as appropriate prepare and circulate copies of minutes thereof.
 - 2. *Safety Compliance:* Comply with Site safety programs, as they apply to RPR, and if required to do so by such safety programs, receive safety training specifically related to RPR’s own personal safety while at the Site.
 - 3. *Liaison*
 - a. Serve as Engineer’s liaison with Contractor. Working principally through Contractor’s authorized representative or designee, assist in providing information regarding the provisions and intent of the Contract Documents.
 - b. Assist Engineer in serving as Owner’s liaison with Contractor when Contractor’s operations affect Owner’s on-Site operations.

- c. Assist in obtaining from Owner additional details or information, when required for Contractor's proper execution of the Work.
4. *Review of Work; Defective Work*
- a. Conduct on-Site observations of the Work to assist Engineer in determining, to the extent set forth in Paragraph 10.02, if the Work is in general proceeding in accordance with the Contract Documents.
 - b. Observe whether any Work in place appears to be defective.
 - c. Observe whether any Work in place should be uncovered for observation, or requires special testing, inspection or approval.
5. *Inspections and Tests*
- a. Observe Contractor-arranged inspections required by Laws and Regulations, including but not limited to those performed by public or other agencies having jurisdiction over the Work.
 - b. Accompany visiting inspectors representing public or other agencies having jurisdiction over the Work.
6. *Payment Requests: Review Applications for Payment with Contractor.*
7. *Completion*
- a. Participate in Engineer's visits regarding Substantial Completion.
 - b. Assist in the preparation of a punch list of items to be completed or corrected.
 - c. Participate in Engineer's visit to the Site in the company of Owner and Contractor regarding completion of the Work, and prepare a final punch list of items to be completed or corrected by Contractor.
 - d. Observe whether items on the final punch list have been completed or corrected.
- D. The RPR will not:
- 1. Authorize any deviation from the Contract Documents or substitution of materials or equipment (including "or-equal" items).
 - 2. Exceed limitations of Engineer's authority as set forth in the Contract Documents.
 - 3. Undertake any of the responsibilities of Contractor, Subcontractors, or Suppliers.
 - 4. Advise on, issue directions relative to, or assume control over any aspect of the means, methods, techniques, sequences or procedures of construction.
 - 5. Advise on, issue directions regarding, or assume control over security or safety practices, precautions, and programs in connection with the activities or operations of Owner or Contractor.
 - 6. Participate in specialized field or laboratory tests or inspections conducted off-site by others except as specifically authorized by Engineer.
 - 7. Authorize Owner to occupy the Project in whole or in part.

ARTICLE 11—CHANGES TO THE CONTRACT

11.05 Owner-Authorized Changes in the Work

SC-11.05 Add new paragraphs immediately after Paragraph 11.05.C:

- D. Except as specifically authorized in writing by the Engineer at the time additional Work is done beyond the original scope of the Contract Documents, the Contractor shall make no claims for additional compensation. The Contractor's plea of ignorance of foreseeable conditions which will create difficulties or hindrances in the execution of the Work will not be acceptable to the Owner as an excuse for any failure of the Contractor to fulfill the requirements of the Contract Documents and shall not be a basis for the Contractor's claim for additional compensation. Any discrepancies in, or conflicts between, the items described in these Contract Documents must be submitted in writing to the Engineer for adjustment prior to proceeding with the Work, as any claims for additional compensation to achieve compliance with the requirements of those items will not be allowed or considered.

ARTICLE 12—CLAIMS

12.01 *Claims*

SC-12.01 Add new paragraphs immediately after Paragraph 12.01.G:

- H. *Claims between Contractors*
 1. Should Contractor cause damage to the Work or property of any separate contractor at the Site, or should any claim arising out of Contractor's performance of Work at the Site be made by any separate Contractor against another Contractor, the Owner, Engineer, or Engineer's Consultants, Contractor shall promptly attempt to settle with such other contractor by agreement, or to otherwise resolve the dispute by arbitration, or at law.
 2. Contractor shall, to the fullest extent permitted by Law, indemnify and hold harmless Owner, Engineer, Engineer's Consultant and the officers, directors, partners, employees, agents and other consultants and subcontractors of each and any of them from and against all claims, costs, losses and damages (including, but not limited to fees and charges of engineers, architects, attorneys and other professionals and court and arbitration costs) arising directly, indirectly, or consequentially out of any action, legal or equitable, brought by any separate contractor against Owner, Engineer, or Engineer's Consultant to the extent that said claim is based on, or arises out of, Contractor's performance of the Work. Should a separate contractor cause damage to the Work or property of Contractor, or, should the performance of the Work by any separate contractor at the Site give rise to any other Claim, Contractor shall not institute any action, legal or equitable, against Owner, Engineer, or Engineer's Consultant or permit any action against any of them to be maintained and continued in its name or for its benefit in any court, or before any arbiter, which seeks to impose liability on, or to recover damages from, Owner, Engineer, or Engineer's Consultant on account of any such damage or Claim.
 3. If Contractor is delayed at any time in performing or furnishing Work by any act or neglect of a separate contractor, and Owner and Contractor are unable to agree as to the extent of any adjustment in Contract Times attributable thereto, Contractor may

make a Claim for an extension of times in accordance with Article 12. An extension of the Contract Times shall be Contractor's exclusive remedy with respect to Owner, Engineer, and Engineer's Consultant(s) for any delay, disruption, interference or hindrance caused by any separate contractor.

ARTICLE 13—COST OF WORK; ALLOWANCES, UNIT PRICE WORK

13.01 Cost of the Work

SC-13.01 Supplement Paragraph 13.01.B.5.c.(2) by adding the following sentence:

The equipment rental rate book that governs the included costs for the rental of machinery and equipment owned by Contractor (or a related entity) under the Cost of the Work provisions of this Contract is the most current edition of Rental Rate Blue Book for Construction Equipment or the AED Green Book: Rental Rates & Specifications for Construction Equipment or as identified during a preconstruction conference and agreed to by Owner, Engineer, and Contractor.

SC-13.01 Supplement Paragraph 13.01.C.2 by adding the following definition of small tools and hand tools:

- a. For purposes of this paragraph, "small tools and hand tools" means any tool or equipment whose current price if it were purchased new at retail would be less than \$500.

13.03 Unit Price Work

SC-13.03 Delete Paragraph 13.03.E in its entirety and insert the following in its place:

E. Adjustments in Unit Price

1. There will be no adjustments in the Unit Prices for Unit Price Work for increased or decreased quantities under this Contract. Quantities for items listed on the Contractor's Bid Form will be measured during construction by Engineer's Field Representative, and the final measured quantities multiplied by the Unit Price shall be used to determine the Contract Price. To complete the Project in accordance with the intent of the Contract Documents it is anticipated that quantities of several items will be more or less than estimated on the Contractor's Bid Form. Accordingly, there will be no compensation for material restocking, if necessary.

ARTICLE 14—TESTS AND INSPECTIONS; CORRECTION, REMOVAL, OR ACCEPTANCE OF DEFECTIVE WORK

SC-14.02 Delete Paragraph 14.02.B in its entirety and insert the following in its place:

- A. Contractor shall retain and pay for the services of an independent inspector, testing laboratory, or other qualified individual or entity to perform all inspections and tests expressly required by the Contract Documents, unless specifically identified as a service to be retained and paid for by the Owner.

ARTICLE 15—PAYMENTS TO CONTRACTOR, SET OFFS; COMPLETIONS; CORRECTION PERIOD

15.01 Progress Payments

SC-15.01 Add the following new Paragraphs immediately following Paragraph 15.01.C.6.e:

- f. Failure to make payment to Subcontractors, Supplier, or labor.
- g. Claims made by Engineer for additional compensation because of Contractor delays or rejection of defective Work.
- h. Liability for liquidated damages has been incurred by Contractor.

15.03 Substantial Completion

SC-15.03 Add the following new subparagraph to Paragraph 15.03.B:

- 1. If some or all of the Work has been determined not to be at a point of Substantial Completion and will require re-inspection or re-testing by Engineer, the cost of such re-inspection or re-testing, including the cost of time, travel and living expenses, will be paid by Contractor to Owner. If Contractor does not pay, or the parties are unable to agree as to the amount owed, then Owner may impose a reasonable set-off against payments due under this Article 15.

15.04 Partial Use or Occupancy

SC-15.04 Add the following new subparagraph to Paragraph 15.04.A:

- 1. Owner may at any time request in writing Contractor to permit Owner to take over operation of any part of the Work although it may not be substantially complete. A copy of such request will be sent to Engineer, and within a reasonable time thereafter Owner, Contractor, and Engineer shall make an inspection of that part of the Work to determine its status of completion and will prepare a list of the items remaining to be completed or corrected prior to final payment. If Contractor does not object in writing to Owner and Engineer that such part of Work is not ready for separate operation by Owner, Engineer will finalize the list of items to be completed or corrected and will deliver such list to Owner and Contractor together with a written recommendation as to the division of responsibility pending final payment between Owner and Contractor with respect to security, operation, safety, maintenance, utilities, insurance, warranties, and guarantees for that part of the Work which will become binding upon Owner and Contractor at the time the Owner takes over such operation (unless they shall have otherwise agreed in writing and so informed Engineer). During such operation and prior to Substantial Completion of such part of Work, Owner shall allow Contractor reasonable access to complete or correct items on said list and to complete other related Work.

ARTICLE 16—SUSPENSION OF WORK AND TERMINATION

16.01 Owner May Suspend Work

SC-16.01 Add the following new paragraph immediately after Paragraph 16.01.A.

- a. Historical/Archaeological Finds: If during the course of construction evidence of deposits of historical or archaeological interest is found, the Contractor shall cease operations affecting

the find and shall notify the Owner, and the State Historical Society or similar agency of reporting within that particular state. No further disturbance of the deposits shall ensue until the Contractor has been notified in writing by the Engineer that he may proceed.

ARTICLE 17—FINAL RESOLUTIONS OF DISPUTES

17.01 Methods and Procedures

SC-17.01 Delete Paragraphs 17.01.A and B in their entirety and replace with the following.

- A. For any conflicts that arise during the design, construction, or following completion of the Project, the Contractor and Engineer agree that all disputes between them arising out of or relating to this agreement shall be resolved, if possible, at the staff level of those involved in the Project. If any conflict or dispute cannot be resolved between the Contractor and Engineer staff involved in the Project, the presidents and project managers of the respective entities will meet to attempt to resolve any dispute. If resolution is not achieved, the dispute shall be submitted to non-binding mediation.
- B. The rights and remedies available to the Contractor shall be limited to breach of Contract, and no other cause or action, including, without limitation, negligence, misrepresentation, or other theory. The Owner or Contractor may assert any such breach of Contract claim in the Morton County District Court in North Dakota. Neither the Owner nor the Contractor shall be entitled to a jury trial for any such action. The right and remedies to the Owner hereunder shall be in addition to and shall not be construed in any way as a limitation of any rights and remedies available to the Owner which are otherwise available by law or contract, by special warranty or guarantee, or by other provisions of the Contract Documents. The provision of this paragraph shall be as effective as if repeated specifically in the Contract Documents in connection with each particular duty, obligation, right, and remedy to which it may apply. All representations, warranties and guarantees made in the Contract Documents shall survive final payment, termination, or completion of this agreement.
- C. No waiver or failure to enforce any part or provision of the Contract Documents, including, but not limited to the change order process, shall be considered a waiver by the Owner of any subsequent default or breach of the same or any other part of provision contained herein, or right to enforce the same or any part of provision contained herein.

17.02 Attorney's Fees

SC-17.02 Add the following new paragraph immediately after Paragraph 17.01.

- A. *Attorneys' Fees:* For any matter subject to final resolution under this Article, the prevailing party shall be entitled to an award of its attorneys' fees incurred in the final resolution proceedings, in an equitable amount to be determined in the discretion of the court, taking into account the parties' initial demand or defense positions in comparison with the final result.

ARTICLE 18—MISCELLANEOUS

None.

EXHIBIT A—SOFTWARE REQUIREMENTS FOR ELECTRONIC DOCUMENT EXCHANGE

Item	Electronic Documents	Transmittal Means	Data Format	Note (1)
a.1	General communications, transmittal covers, meeting notices and responses to general information requests for which there is no specific prescribed form.	Email	Email	
a.2	Meeting agendas, meeting minutes, RFI's and responses to RFI's, and Contract forms.	Email w/ Attachment	PDF	(2)
a.3	Contactors Submittals (Shop Drawings, "or equal" requests, substitution requests, documentation accompanying Sample submittals and other submittals) to Owner and Engineer, and Owner's and Engineer's responses to Contractor's Submittals, Shop Drawings, correspondence, and Applications for Payment.	Email w/ Attachment	PDF	
a.4	Correspondence; milestone and final version Submittals of reports, layouts, Drawings, maps, calculations and spreadsheets, Specifications, Drawings and other Submittals from Contractor to Owner or Engineer and for responses from Engineer and Owner to Contractor regarding Submittals.	Email w/ Attachment or LFE	PDF	
a.5	Layouts and drawings to be submitted to Owner for future use and modification.	Email w/ Attachment or LFE	DWG	
a.6	Correspondence, reports and Specifications to be submitted to Owner for future word processing use and modification.	Email w/ Attachment or LFE	DOC	
a.7	Spreadsheets and data to be submitted to Owner for future data processing use and modification.	Email w/ Attachment or LFE	EXC	
a.8	Database files and data to be submitted to Owner for future data processing use and modification.	Email w/ Attachment or LFE	DB	
Notes				
(1)	All exchanges and uses of transmitted data are subject to the appropriate provisions of Contract Documents.			
(2)	Transmittal of written notices is governed by Paragraph 18.01 of the General Conditions.			
Key				
Email	Standard Email formats (.htm, .rtf, or .txt). Do not use stationery formatting or other features that impair legibility of content on screen or in printed copies			
LFE	Agreed upon Large File Exchange method (FTP, CD, DVD, hard drive)			
PDF	Portable Document Format readable by Adobe® Acrobat Reader			
DWG	Autodesk® AutoCAD .dwg format			
DOC	Microsoft® Word .docx format			
EXC	Microsoft® Excel .xls or .xml format			
DB	Microsoft® Access .mdb format			

This page intentionally left blank

This page intentionally left blank

CHANGE ORDER NO.: _____

Owner:	City of Mandan	Owner's Project No.:	1062
Engineer:	AE2S	Engineer's Project No.:	P00510-2026-002
Contractor:		Contractor's Project No.:	
Project:	Mandan South Side Reservoir Coating		
Contract Name:	Contract No. 1 – General Construction		
Date Issued:		Effective Date of Change Order:	

The Contract is modified as follows upon execution of this Change Order:

Description:

Attachments:

Change in Contract Times

Change in Contract Price

Original Contract Price: \$ _____	Original Contract Times: Substantial Completion: <u>September 30, 2026</u> Ready for final payment: <u>October 15, 2026</u>
[Increase] [Decrease] from previously approved Change Orders No. 1 to No. [Number of previous Change Order] : \$ _____	[Increase] [Decrease] from previously approved Change Orders No.1 to No. [Number of previous Change Order] : Substantial Completion: _____ Ready for final payment: _____
Contract Price prior to this Change Order: \$ _____	Contract Times prior to this Change Order: Substantial Completion: _____ Ready for final payment: _____
[Increase] [Decrease] this Change Order: \$ _____	[Increase] [Decrease] this Change Order: Substantial Completion: _____ Ready for final payment: _____
Contract Price incorporating this Change Order: \$ _____	Contract Times with all approved Change Orders: Substantial Completion: _____ Ready for final payment: _____

Recommended by Engineer (if required)

Accepted by Contractor

By: _____

Title: _____

Date: _____

Authorized by Owner

Approved by Funding Agency (if applicable)

By: _____

Title: _____

Date: _____

This page intentionally left blank

This page intentionally left blank

DIVISION 01 GENERAL REQUIREMENTS

SECTION 01 11 00
SUMMARY OF WORK

PART 1 GENERAL

1.01 SUMMARY

- A. This Section includes:
 - 1. Project Description.
 - 2. Contracts.
 - 3. Contractual, Administrative, and Procedural Sections Applicable to All Contracts.
 - 4. Description of Work for Base Bid
 - 5. Work by Owner.
 - 6. Contractor Use of Site and Premises.
 - 7. Temporary Construction.
 - 8. Maintenance of Water Service.
 - 9. Work on Street Right-of-Way.
 - 10. Access to Streets.
 - 11. Access to Property.
 - 12. Coordination.
 - 13. Owner Occupancy Requirements.

1.02 PROJECT DESCRIPTION

- A. Major components of the Project include:
 - 1. Surface preparation and coating of 4MG ground storage reservoir walls and dome with approximate surface area of 18,900 SF.

1.03 CONTRACTS

- A. The Project can be completed as a single Prime Contract for General Construction.

1.04 CONTRACTUAL, ADMINISTRATIVE, AND PROCEDURAL SECTIONS APPLICABLE TO ALL CONTRACTS

- A. Front Ends
 - 1. Bidding Documents: All Sections.
 - 2. Contract Documents: All Sections.
- B. Division 01 – General Requirements: All Sections.
- C. Division 09 – Finishes, Section 09 90 01

1.05 DESCRIPTION OF WORK FOR BASE BID

- A. Coatings: includes all costs for labor, skill, tools, materials, and equipment required for: surface preparation, priming, painting, and cleanup of entire exterior surfaces associated with the ground storage reservoir.
- B. Specifications: All Divisions.

1.06 WORK BY OWNER

- A. There will be no work by the owner.

1.07 CONTRACTOR USE OF SITE AND PREMISES

- A. Contractor shall limit use of the site for work and storage, to allow for Owner occupancy as required.
- B. Contractor shall confine construction equipment, storage of materials and equipment, and operations of workmen to areas permitted by law, ordinances, easements, permits, or requirements of the Contract Documents, and shall not unreasonably encumber Project Site with construction equipment or other materials or equipment.
- C. Contractor shall assume full responsibility for the protection and safekeeping of products stored on site under their respective Contracts.
- D. Contractor shall move any stored products, under Contractor's control, which interfere with operations of the Owner or public.
- E. Contractor shall notify and coordinate construction activity with local Police Department, Fire Department, and Hospital/Ambulance Services as applicable to the construction. Notice shall include Work schedule as construction proceeds, when Work affects or obstructs streets and intersections, and when Work is completed or suitable access is available in streets and intersections.
- F. Contractor shall notify and coordinate with right-of-way and easement owners. Notice shall include Work schedule as construction proceeds, when Work affects or obstructs intersections and streets, and when Work is completed or suitable access is available in streets or intersections.
- G. Contractor shall provide the name, address, and telephone number of person who has immediate access to equipment and is authorized to make emergency repairs to Contractor's Work, such as to correct trench cave-ins, move excavated material, move traffic control signage, move and/or repair construction access barricades and fences, and correct other problems during weekends and off-work hours so access can be maintained for fire fighting and ambulance equipment, to maintain barricades for public safety, and to facilitate Owner occupancy requirements.
- H. Contractor shall furnish, erect, and maintain warning lights, signs, and barricades as required by the specifications, Owner, Engineer, or City/County ordinances to adequately warn the public from hazardous site conditions, materials, Contractor's equipment, etc., resulting from the construction. The Contractor shall comply with all local and State ordinances such as working hours, noise abatement, etc. All equipment shall have mufflers on engine exhaust systems, and compressors, dust collectors, and other paint coating removal and application equipment shall be quiet-type models.
- I. Contractor shall protect residential properties and City structures from overspray at

all times. Clean up from coating overspray on any residential properties or City Structures not part of the project will be the responsibility of the Contractor.

1.08 TEMPORARY CONSTRUCTION

- A. All temporary construction related to the Work of the Project shall be the responsibility of the Contractor.

1.09 WORK ON STREET RIGHT-OF-WAY

- A. All Work performed within the street right-of-way or utility easements shall be performed in accordance with the North Dakota Standards for safety, protection of the public, signage, flagging, and surface restoration. Contractor shall be responsible for maintaining traffic at all times.
- B. Contractor's traffic control including signage, flagging, barricades, and other means for protection of the public shall be in accordance with the approved traffic control plan, and the Manual of Uniform Traffic Control Devices, latest version.
- C. All other costs associated with special requirements for Work on street right-of-way or utility easements shall be included in the lump sum bid price for that item of Work being performed.

1.10 ACCESS TO STREETS

- A. Maintain suitable means of access for adjacent property owners.
- B. The Contractor shall be responsible for all construction signage, flagging, and protection of the public. Signage shall conform to requirements as set forth in the Manual on Uniform Traffic Control devices. Signage for each area to be constructed shall be approved by the Engineer and Owner and in place prior to the start of construction in that area.
- C. Whenever construction is stopped due to inclement weather, weekends, holidays or other reasons, suitable access shall be provided for all property owners at all times.

1.11 ACCESS TO PROPERTY

- A. The Contractor shall maintain access or altered means of access to existing property affected by construction progress for the duration of the construction period. Cost of providing, maintaining, and removing access roadways shall be incidental to the Project.
- B. Maintain access at all times when construction is stopped due to inclement weather, weekends, holidays, or other reasons.

1.12 COORDINATION

- A. Coordinate work of the various Sections of Specifications to assure efficient and orderly sequence of installation of construction elements, with provisions for accommodating items installed later.

- B. Verify characteristics of elements of interrelated materials are compatible; coordinate work of various Sections having interdependent responsibilities for installing, connection to, and placing in service, such materials.

1.13 OWNER OCCUPANCY REQUIREMENTS

- A. Cooperate with Owner to minimize conflict and to facilitate Owner's operations. Schedule all Work to accommodate this requirement. No interruption will be permitted which adversely affects the degree of service the Owner provides. Contractor shall provide temporary facilities and make temporary modifications as necessary to keep the existing facilities and services in operation during the construction period.
- B. Work requiring planned shutdown, once undertaken, must be substantially completed to permit restart of facility within scheduled time. Critical Work elements may require continuous, non-stop work during or throughout the night to complete within schedule.
- C. Pre-plan, schedule, coordinate, and stage for required materials, manpower, contractors, subcontractors, etc. to complete critical elements of Work.
- D. Existing materials and equipment removed and not reused as part of the Work, shall remain the Owner's property, except any item the Owner does not wish to salvage. The Contractor shall properly dispose of unwanted items at no additional cost to Owner.

1.14 WORK SEQUENCE

- A. Coordinate construction schedule and operations with Owner and Engineer to accommodate Owner occupancy requirements.
- B. Limit work to project site.
- C. Buried Utilities.
 - 1. A list of utilities include the following:
 - 1) Power supply wires.
 - 2) Electrical vaults.
 - 3) Gas piping.
 - 4) Telephone cables.
 - 5) Fiber Optic.
 - 2. Any required temporary electrical wire or connections with the associated Utility Company are the sole responsibility of the Contractor.
- D. Damages.
 - 1. All parties involved with the proposed Work including the Contractor, Owner, and Engineer, all need to strive for a common goal of keeping the

public service operational and making safe and dependable water in an adequate volume to meet all water use requirements.

PART 2 PRODUCTS

Not Used.

PART 3 EXECUTION

Not Used.

END OF SECTION

This page intentionally left blank

SECTION 01 26 00
CONTRACT MODIFICATION PROCEDURES

PART 1 GENERAL

1.01 SUMMARY

- A. Section includes:
 - 1. Submittals.
 - 2. Documentation of Change in Contract Price and Contract Time.
 - 3. Change Procedures.
 - 4. Work Directive Change.
 - 5. Stipulated Price Change Order.
 - 6. Unit Price Change Order
 - 7. Time and Material Change Order.
 - 8. Execution of Change Orders.
 - 9. Correlation of Contractor Submittals.

- B. Related Sections include:
 - 1. Document C-520 – Agreement Between Owner and Contractor.
 - 2. Document C-700 – General Conditions.
 - 3. Document C-800 – Supplementary Conditions.
 - 4. Section 01 29 00 – Payment Procedures.
 - 5. Section 01 33 00 – Submittals.
 - 7. Section 01 77 00 – Closeout Procedures.

1.02 SUBMITTALS

- A. Submit name of the individual authorized to receive change documents and be responsible for informing others in Contractor's employ or Subcontractors of changes to the Work.

- B. Change Order Form: EJCDC form C-941 (2018 Edition).

- C. Work Change Directive Form: EJCDC form C-940 (2018 Edition).

1.03 DOCUMENTATION OF CHANGE IN CONTRACT PRICE AND CONTRACT TIME

- A. Contractor will not be entitled to any compensation for causes resulting in delays or hindrances to the Work. Extensions of time will be granted for unavoidable delays, as set forth in the General Conditions. The Engineer must receive a written request for time extension from the Contractor not more than 30 days after commencement of delay before any time extension will be considered. Requests made beyond the 30-day limit will be cause for denial. Any extension of time will not relieve the Contractor or his sureties from their obligations which shall remain in full force and effect until the satisfactory discharge of the contract.

- B. Maintain detailed records of work done on a time and material basis. Provide full information required for evaluation of proposed changes, and to substantiate costs of changes in the Work.
- C. Document each quotation for a change in cost or time with sufficient data to allow evaluation of the quotation.
- D. Provide additional data to support computations:
 - 1. Quantities of products, labor, and equipment.
 - 2. Taxes, insurance, and bonds.
 - 3. Overhead and profit.
 - 4. Justification for any change in Contract Time.
 - 5. Credit for deletions from Contract, similarly documented.
- E. Support each claim for additional costs, and for work done on a time and material basis, with additional information:
 - 1. Origin and date of claim.
 - 2. Dates and times work was performed, and by whom.
 - 3. Time records and wage rates paid.
 - 4. Invoices and receipts for products, equipment, and subcontracts, similarly documented.

1.04 CHANGE PROCEDURES

- A. The Engineer will advise of minor changes in the Work not involving an adjustment to Contract Price or Contract Time by issuing supplemental instructions.
- B. The Engineer may issue a Proposal Request which includes a detailed description of a proposed change with supplementary or revised Drawings and specifications and a change in Contract Time for executing the change. Contractor will prepare and submit an estimate within seven (7) days.
- C. The Contractor may propose a change by submitting a request for change to the Engineer, describing the proposed change and its full effect on the Work, with a statement describing the reason for the change, and the effect on the Contract Price and Contract Time with full documentation and a statement describing the effect on Work by separate or other contractors.

1.05 WORK DIRECTIVE CHANGE

- A. Engineer may issue a document, signed by the Owner, instructing the Contractor to proceed with a change in the Work, for subsequent inclusion in a Change Order.
- B. The document will describe changes in the Work and will designate method of determining any change in Contract Price or Contract Time.
- C. Contractor shall promptly execute the change in Work.

1.06 STIPULATED PRICE CHANGE ORDER

- A. Based on Proposal Request and Contractor's fixed price quotation or Contractor's request for a Change Order as approved by Engineer.

1.07 UNIT PRICE CHANGE ORDER

- A. For pre-determined unit prices and quantities, the Change Order will be executed on a fixed unit price basis.
- B. For unit costs or quantities of units of work which are not pre-determined, execute Work under a Work Directive Change.
- C. Changes in Contract Sum/Price or Contract Time will be computed as specified for Time and Material Change Order.

1.08 TIME AND MATERIAL CHANGE ORDER

- A. Submit itemized account and supporting data after completion of change, within time limits indicated in the Conditions of the Contract.
- B. Engineer will determine the change allowable in Contract Price and Contract Time as provided in the Contract Documents.
- C. Maintain detailed records of Work done on Time and Material basis.
- D. Provide full information required for evaluation of proposed changes, and to substantiate costs for changes in the Work.

1.09 EXECUTION OF CHANGE ORDERS

- A. Execution of Change Orders: Engineer will prepare the formal Change Order document(s) and forward to Contractor for signature(s). Engineer will then present the proposed Change Order to Owner for approval. Upon obtaining approval, the Change Order will be submitted to the Owner for signatures as provided in Conditions of Contract.

1.10 CORRELATION OF CONTRACTOR SUBMITTALS

- A. Promptly revise Schedule of Values and Application for Payment forms to record each authorized Change Order as a separate line item and adjust the Contract Price.
- B. Promptly revise progress schedules to reflect any change in Contract Time, revise sub-schedules to adjust times for other items of work affected by the change, and resubmit.
- C. Promptly enter changes in Project Record Documents.

PART 2 PRODUCTS

Not Used.

PART 3 EXECUTION

Not Used.

END OF SECTION

SECTION 01 29 00
PAYMENT PROCEDURES

PART 1 GENERAL

1.01 SUMMARY

A Section includes:

1. Format and Preparation of Applications for Payment
2. Schedule of Values
3. Lump Sum Item Description for Schedule of Values
4. Submittal Procedures.
5. Substantiating Data.

B Related Sections include:

1. Document C-520 – Agreement Between Owner and Contractor.
2. Document C-700 – General Conditions.
3. Document C-800 – Supplemental Conditions.
4. Section 01 26 00 – Contract Modification Procedures.
5. Section 01 33 00 – Submittals.
6. Section 01 77 00 – Closeout Procedures.

1.02 FORMAT AND PREPARATION OF APPLICATIONS FOR PAYMENT

A Utilize: EJCDC Application for Payment Form (form C-620, 2018 Edition). Include continuation sheets when required.

B Preparation:

1. Present required information in an electronic media printout.
2. Execute certification by signature of authorized officer.
3. Use data from approved Schedule of Values. Provide dollar value in each column for each line item for portion of Work performed and for stored Products.
4. List each authorized Change Order as an extension on Continuation Sheet, listing Change Order number and dollar amount as for an original item of Work.

C Prepare Application for Final Payment as specified in Section 01 77 00.

1.03 SCHEDULE OF VALUES

A Submit:

1. Typed schedule of values in format similar to EJCDC Application for Payment (C-620)
2. Include Lump Sum item listed in Paragraph 1.04 below.
3. Refer to General Conditions of the Contract.

B Format:

1. Utilize the Table of Contents within Contract Documents.
2. Identify line items corresponding with number and title of Specifications Section.
3. Identify site mobilization, bonds, and insurance.
4. Include within each line item a direct proportional amount of Contractor's overhead and profit.

C Revise Schedule of Values to list approved Change Orders and submit with each Application for Payment.

1.04 LUMP SUM SCHEDULE OF VALUE ITEMS AND PROCEDURES FOR ALL CONTRACTS

A Bonding:

1. This item shall consist of all bonding and insurance for all Work included within the Construction Contract. The bonding and insurance shall be limited to three percent (3%) of the total Contract Bid Price.

B Mobilization:

1. This item shall consist of all work and operations including but not limited to: the movement of personnel, equipment, supplies, and incidentals to and from the Project site; for the establishment and removal of all offices, storage facilities, Contractor's buildings and other facilities necessary for Work on the Project; for all licenses, fees, and permits; and for all other work and operations which must be performed or cost incurred prior to beginning and after completion of Work on the various items on the Project Site.
2. When partial payments are made on the Contract, payment for mobilization will be made according to the following schedule:
 - a When 5 percent of the original contract amount is earned, 25 percent of the amount bid for mobilization, or 1.5 percent of the original contract amount, whichever is less, will be paid.

- b When 10 percent of the original contract amount is earned, 50 percent of the amount bid for mobilization, or 5 percent of the original contract amount, whichever is less, will be paid.
 - c When 25 percent of the original contract amount is earned, 60 percent of the amount bid for mobilization, or 6 percent of the original contract amount, whichever is less, will be paid.
 - d When 65 percent of the original contract amount is earned, 90 percent of the amount bid for mobilization, or 9 percent of the original contract amount, whichever is less, will be paid.
 - e When 80 percent of the original contract amount is earned, 100 percent of the amount bid for mobilization, or 10 percent of the original contract amount, whichever is less, will be paid.
3. Upon completion of all Work on the Project, payment of any amount bid for mobilization in excess of 10 percent of the total contract amount will be paid.

C Values By Division

1. The following Schedule of Value level of detail requirements apply to all Contractors and Subcontractors.
- a For each specification division of the Project a value shall be provided.
 - b For each division value greater than \$25,000, values for sub-divisions shall be provided.
 - c For each sub-division value greater than \$25,000, additional value breakdown and details shall be provided.

D Contractor will be paid for items listed in the approved Schedule of Values as detailed above. Contractor shall submit Schedule of Values in writing to Engineer for approval. No payment on any items shall be made until written approval is finalized. The Schedule of Values will provide the basis for the Contractors Applications for Payment based on observed materials stored and construction progress.

1.05 SUBMITTAL PROCEDURES

A Submittals:

- 1. One (1) electronic copy of each Application for Payment.
- 2. Updated construction schedule with each Application for Payment.
- 3. Payment Periods: As stipulated in the Agreement.

4. Submit with transmittal letter as specified for Submittals in
Section 01 33 00
5. Completion of Project closeout procedures as indicated in Section 01 77
00 must precede or coincide with the submittal of final application for
payment.

1.06 SUBSTANTIATING DATA

- A When Engineer requires substantiating information, submit data justifying dollar
amounts in question.
- B Provide one (1) electronic copy of data with the cover letter for each copy of
submittal. Show application number and date, and line item by number and
description.
- C Provide one (1) electronic copy of invoice(s) for payment of materials stored on-
site. Payment will not be made for materials that are not stored on-site or within a
bonded warehouse that has been approved by Engineer and Owner.

PART 2 PRODUCTS

Not Used.

PART 3 EXECUTION

Not Used.

END OF SECTION

SECTION 01 33 00

SUBMITTALS

PART 1 GENERAL

1.01 SUMMARY

- A. Section Includes:
 - 1. Submittal Procedures.
 - 2. Construction Progress Schedules.
 - 3. Proposed Products List.
 - 4. Product Data.
 - 5. Shop Drawings.
 - 6. Samples.
 - 7. Test Reports.
 - 8. Manufacturer's Certificates.
 - 9. Manufacturer's Instructions.
 - 10. Manufacturer's Field Reports.

- B. Related Sections include:
 - 1. Section 01 26 00 – Contract Modification Procedures.
 - 2. Section 01 29 00 – Payment Procedures.
 - 3. Section 01 77 00 –Closeout Procedures.
 - 4. Divisions 09 – Reservoir And Appurtenances Painting and Coating.

1.02 SUBMITTAL PROCEDURES

- A. Transmit each submittal with transmittal form provided by Engineer during the Preconstruction Conference.

- B. Sequentially number the transmittal form. Submit revised submittals with original number and a sequential alphabetic suffix.

- C. Identify Project, Contractor, Subcontractor, or supplier; pertinent Drawing and detail number, and specification section number, as appropriate.

- D. Completely review all submittal materials prior to submission to Engineer. Apply Contractor's stamp, signed or initialed certifying that review, approval, verification of Products required, field dimensions, adjacent construction Work, and coordination of information is in accordance with the requirements of the Work and Contract Documents.

- E. Schedule submittals to expedite the Project, and deliver to Engineer at business address. Coordinate submission of related items.

- F. For each submittal for review allow, at minimum, fifteen (15) days excluding delivery time to and from the Contractor.

- G. Identify variations from Contract Documents and Product or system limitations that may be detrimental to successful performance of the completed Work. Highlight

and/or clearly designate specific product details and information so as to confirm product meets or exceeds product specifications.

- H.
- I. When revised for resubmission, identify all changes made since previous submission.
- J. Distribute copies of reviewed submittals as appropriate. Instruct parties to promptly report any inability to comply with requirements. Clearly transmit Engineer review comments to suppliers and subcontractors as required to minimize product delivery errors and miscommunications.
- K. Submittals not requested will not be recognized or processed.

1.03 CONSTRUCTION PROGRESS SCHEDULES

- A. Submit initial schedule in duplicate within 15 days after date of Owner-Contractor Agreement for Engineer review and comment. Revise and resubmit as required.
- B. Submit revised schedules with each Application for Payment, identifying changes since previous version. Application for Payment will not be processed until updated construction schedule has been submitted.
- C. Submit a horizontal bar chart with a separate line for each major portion of Work or operation, showing the proposed start and completion dates of each major portion of Work and minor portions of Work required to adequately represent the progress schedule.
- D. Show complete sequence of construction by activity, identifying Work of separate stages and other logically grouped activities. Indicate the early and late start, early and late finish, float dates, and duration.
- E. Indicate estimated percentage of completion for each item of Work at each submission.
- F. Indicate submittal dates required for shop drawings, product data, samples, and product delivery dates.

1.04 PROPOSED PRODUCTS LIST

- A. Within fifteen (15) days after date of Owner-Contractor Agreement, submit list of major products proposed for use, with name of manufacturer, trade name, and model number of each product.
- B. For products specified only by reference standards, give manufacturer, trade name, model or catalog designation, and reference standards.

1.05 PRODUCT DATA

- A. Upon receiving product data submittals from supplier(s), review each page of each submittal and address any and all identified comments, if any and as applicable. After review, produce copies and submit to Engineer in accordance with SUBMITTAL PROCEDURES article above (paragraph 1.02) and for record documents purposes described in Section 01 77 00 – Closeout Procedures.
- B. Submit to Engineer for review for the limited purpose of checking for conformance with information given and the design concept expressed in the Contract Documents.
- C. Submit the number of copies that the Contractor requires, plus one (1) electronic copy that will be retained by the Engineer.
- D. Mark each copy to identify applicable products, models, options, and other data. Supplement manufacturer's standard data to provide information specific to this Project.

1.06 SHOP DRAWINGS

- A. Upon receiving shop drawing submittals from supplier(s), review each page of each submittal and address any and all identified comments, if any and as applicable. After review, produce copies and submit to Engineer in accordance with SUBMITTAL PROCEDURES article above (paragraph 1.02) and for record documents purposes described in Section 01 77 00 – Closeout Procedures.
- B. Submit to Engineer for review for the limited purpose of checking for conformance with information given and the design concept expressed in the Contract Documents
- C. Submit the number of copies that Contractor requires, plus one (1) electronic copy that will be retained by Engineer and Engineer's Subconsultant, as applicable.

1.07 SAMPLES

- A. Upon receiving sample submittals from supplier(s), review each page of each submittal and address any and all identified comments, if any and as applicable. After review, produce copies and submit to Engineer in accordance with SUBMITTAL PROCEDURES article above (paragraph 1.02) and for record documents purposes described in Section 01 77 00 – Closeout Procedures.
- B. Submit to Engineer for review for the limited purpose of checking for conformance with information given and the design concept expressed in the Contract Documents.
- C. Submit samples to illustrate functional and aesthetic characteristics of the Product, with integral parts and attachment devices. Coordinate sample submittals for interfacing work.
- D. Include identification on each sample, with full Project information.

- E. Submit the number of samples specified in individual specification sections; two (2) of which will be retained by Engineer and one (1) of which will be retained by Engineer's Subconsultant, as applicable.
- F. Reviewed samples that may be used in the Work are indicated in individual specification sections.
- G. Samples will not be used for testing purposes unless specifically stated in the specification section.

1.08 TEST REPORTS

- A. Submit for Engineer's knowledge as contract administrator on behalf of Owner.
- B. Submit test reports for information for the limited purpose of assessing conformance with information given and the design concept expressed in the Contract Documents.
- C. Retain one (1) electronic copy of all test reports and results on-site in a location accessible to Engineer

1.09 MANUFACTURER'S CERTIFICATES

- A. When specified in individual specification sections, submit certification by the manufacturer, installation/application Subcontractor, or the Contractor to Engineer, in quantities specified for Product Data.
- B. Indicate material or Product conforms to or exceeds specified requirements. Submit supporting reference data, affidavits, and certifications as appropriate.
- C. Certificates may be recent or previous test results on material or Product, but must be acceptable to Engineer.

1.10 MANUFACTURER'S INSTRUCTIONS

- A. When specified in individual specification sections, submit copies of printed instructions for delivery, storage, assembly, installation, start-up, adjusting, and finishing, to Engineer for delivery to Owner in quantities specified for Product Data.
- B. Indicate special procedures, perimeter conditions requiring special attention, and special environmental criteria required for application or installation.
- C.

1.11

PART 2 PRODUCTS

Not Used.

PART 3 EXECUTION

Not Used.

END OF SECTION

This page intentionally left blank

SECTION 01 52 00
CONSTRUCTION FACILITIES AND TEMPORARY CONTROLS

PART 1 GENERAL

1.01 SUMMARY

A. Section Includes:

1. Temporary Ventilation
2. Temporary Sanitary Facilities.
3. Protection of Installed Work.
4. Security.
5. Parking.
6. Progress Cleaning and Waste Removal.
7. Removal of Utilities, Facilities, and Controls.

B. Related Sections include:

1. Section 01 11 00 - Summary of Work.
2. Section 01 77 00 – Closeout Procedures.

1.03 TEMPORARY VENTILATION

- A. Ventilate enclosed areas to assist curing of materials, to dissipate humidity, and to prevent accumulation of dust, fumes, vapors, or gases.

1.06 TEMPORARY SANITARY FACILITIES

- A. Provide and maintain required facilities and enclosures.

1.09 PROTECTION OF INSTALLED WORK

- A. Protect installed Work and provide special protection where specified in individual specification sections.
- B. Provide temporary and removable protection for installed Products. Control activity in immediate work area to prevent damage.
- C. Prohibit traffic from landscaped areas.

1.10 SECURITY

- A. Provide security and facilities to protect Work, existing facilities, and Owner's operations from unauthorized entry, vandalism, or theft.
- B. Coordinate with Owner's security program.

1.12 PARKING

- A. Provide parking to accommodate construction personnel.

1.13 PROGRESS CLEANING AND WASTE REMOVAL

- A. Maintain areas free of waste materials, debris, and rubbish. Maintain site in a clean and orderly condition.
- B. Collect and remove waste materials, debris, and rubbish from site weekly and dispose off-site.
- C. Contractor shall maintain site clean and free of obstructions that may cause injuries or otherwise prevent staff (Owner, Engineer, Subcontractors, etc.) from performing their job effectively.

1.15 REMOVAL OF UTILITIES, FACILITIES, AND CONTROLS

- A. Remove temporary equipment, facilities, materials, prior to Substantial Completion inspection.
- B. Clean and repair damage caused by installation or use of temporary work.
- C. Restore existing and permanent facilities used during construction to original condition.
- D. Restore staging area to original conditions upon completion of construction.

PART 2 PRODUCTS

Not Used.

PART 3 EXECUTION

Not Used.

END OF SECTION

SECTION 01 77 00
CLOSEOUT PROCEDURES

PART 1 GENERAL

1.01 SUMMARY

- A. Section Includes:
 - 1. Closeout Procedures.
 - 2. Final Cleaning.
 - 3. Adjusting.
 - 4. Project Record Documents.
 - 5. Spare Parts and Maintenance Products.
 - 6. Warranties and Bonds.
 - 7. Maintenance Service.

- B. Related Sections include:
 - 1. Section 01 29 00 – Payment Procedures.
 - 2. Section 01 33 00 – Submittals.
 - 3. Section 01 52 00 – Construction Facilities and Temporary Controls.

1.02 CLOSEOUT PROCEDURES

- A. Submit written certification that Contract Documents have been reviewed, Work has been inspected, and that Work is complete in accordance with Contract Documents and ready for Engineer's review.

- B. Provide submittals to Engineer that are required by governing or other authorities.

- C. Submit final Application for Payment identifying total adjusted Contract Sum, previous payments, and sum remaining due.

- D. Submit lien waivers and project record documents.

1.03 FINAL CLEANING

- A. Execute final cleaning prior to final project inspection.

- B. Clean site; sweep paved areas, rake clean landscaped surfaces.

- C. Restore site to original condition.

- D. Clean debris from roadways, driveways, and drainage systems.

- E. Remove waste and surplus materials, rubbish, and construction facilities from the site.

1.04 ADJUSTING

- A. Adjust operating Products and equipment to ensure smooth and unhindered operation.

1.05 PROJECT RECORD DOCUMENTS

- A. All Contractors will be required to accurately and consistently record all required Record Drawing information at all times during construction for future use by the Owner.
- B. Maintain on-site one set of the following record documents; record actual revisions to the Work as they occur on a daily basis:
 - 1. Specifications.
 - 2. Addenda.
 - 3. Change Orders and other modifications to the Contract.
 - 4. Reviewed Shop Drawings, Product Data, and Samples.
 - 5. Manufacturer's instruction for assembly, installation, and adjusting.
 - 6. Manufacturer's certificates and field reports.
- C. Ensure entries are complete and accurate, enabling current and future reference by Owner and Engineer.
- D. Store record documents separate from documents used for construction.
- E. Record information concurrent with construction progress.
- F. Record Specifications: Legibly mark and record at each Product section a description of actual Products and materials installed, including the following:
 - 1. Manufacturer's name and product model and number.
 - 2. Product substitutions or alternates utilized.
 - 3. Changes made by Addenda and modifications.
- G. Submit documents to Engineer with submittal of Final Application for Payment. Final Application will not be processed until Record Documents are received and reviewed by Owner and Engineer to be satisfactory for intended purpose.

1.06 SPARE PARTS AND MAINTENANCE PRODUCTS

- A. Provide spare parts, maintenance, and extra Products in quantities specified in individual specification sections.
- B. Deliver to Project site and place in location as directed by Owner; obtain receipt prior to final payment.

1.07 WARRANTIES AND BONDS

- A. Provide triplicate notarized copies.
- B. Execute and assemble transferable warranty documents from Subcontractors, suppliers, and manufacturers.
- C. Provide Table of Contents and assemble in D size three ring binder with durable plastic cover. Provide four (4) copies of each binder.
- D. Submit prior to Final Application for Payment.
- E. For items of Work delayed beyond date of Substantial Completion, provide updated submittal within 10 days after acceptance, listing date of acceptance as start of warranty period.

1.08 MAINTENANCE SERVICE

- A. Furnish service and maintenance of components during the warranty period.
- D. Maintenance service shall not be assigned or transferred to any agent or Subcontractor without prior written consent of the Owner.

PART 2 PRODUCTS

Not Used.

PART 3 EXECUTION

Not Used.

END OF SECTION

This page intentionally left blank

DIVISION 09 FINISHES

SECTION 09 90 01

RESERVOIR AND APPURTENANCES PAINTING AND COATING

PART 1 GENERAL

1.01 SUMMARY

- A. Section includes:
 - 1. Surface preparation.
 - 2. Coatings.
 - 3. Schedule.
- B. Related Sections include, but are not limited to:
 - 1. Section 01 33 00 – Submittals.

1.02 REFERENCES

- A. Reference standards include, but are not limited to:
 - 1. American National Standards Institute (ANSI).
 - 2. American Society for Testing Materials (ASTM).
 - 3. American Water Works Association (AWWA).
 - 4. ANSI/NSF 61 – Drinking Water System Components – Health Effects.
 - 5. ASTM D16 – Standard Terminology for Paint, Related Coatings, Materials and Applications.
 - 6. ASTM D3359 – Standard Test Methods For Rating Adhesion by Tape Test.
 - 7. ASTM D4263 - Indicating Moisture in Concrete by the Plastic Sheet Method.
 - 8. National Association of Corrosion Engineers International (NACE) – Industrial Maintenance Painting.

1.03 DEFINITIONS

- A. Conform to ASTM D16 for interpretation of terms used in this Section.
- B. Dry Film Thickness (DFT): Thickness of a coat of paint in fully cured state measured in mils (1/1000 inch).

1.04 QUALITY ASSURANCE

- A. Product Manufacturer:

1. Specialize in manufacture of coatings with a minimum of five (5) years successful experience.
 2. Able to demonstrate successful performance on comparable projects.
 3. Single source responsibility: coatings and coating application accessories shall be Products of a single manufacturer.
- B. Contractor:
1. Company specializing in commercial painting and finishing with two (2) years documented experience.
 2. Employ persons trained for application of specified coatings.
 3. Must have a letter from product manufacturer certifying they are an approved applicator.
 4. Manufacturer's certification that proposed coating system meets specified performance requirements.
 5. SSPC visual standards onsite.
 6. Paint thickness measurement instrument onsite.
- C. Pre-Application Meeting:
1. Convene a pre-application meeting two (2) weeks before the start of application of coating systems.
 2. Require attendance of parties directly affecting work of this section, including the Contractor, Engineer, applicator, and manufacturer's representative.
 3. Review environmental requirements, protection of surfaces not scheduled to be coated, materials, surface preparation, application, curing, disinfection, repair, field quality control, cleaning, protection of coating systems, one-year inspection, and coordination of other work.

1.05 SUBMITTALS

- A. Comply with Section 01 33 00 – Submittals.
- B. Product Data: submit manufacturer's Product data for each coating including generic description, complete technical data, surface preparation, and application instructions.
- C. Color Samples: submit two (2) sample sheets illustrating available colors for each scheduled surface finish Product.
- D. Potable Water Certification: submit certification that liner material has been classified by an ANSI certified laboratory to ANSI/NSF 61 in tanks, pipes, and joints.

- E. Environmental Regulations: Submit certification stating coating systems to be applied are in compliance with federal environmental Volatile Organic Compounds (VOC) regulations.
- F. Manufacturer's Quality Assurance: submit manufacturer's certification that coatings comply with specified requirements and are suitable for intended application.
- G. Maintenance Manual: submit maintenance manual containing instructions for the Owner on how to properly maintain coatings.
- H. Warranty: submit to Owner manufacturer's standard warranty.

1.06 DELIVERY, STORAGE, AND HANDLING

- A. Delivery:
 - 1. Deliver materials to site in manufacturer's original, unopened containers and packaging with labels clearly indicating:
 - a. Coating or material name.
 - b. Manufacturer.
 - c. Color name and number.
 - d. Batch or lot number.
 - e. Date of manufacture.
 - f. Mixing or thinning instruction.
 - g. Coverage.
 - h. Surface preparation.
 - i. Drying time.
 - j. Cleanup.
 - 2. Inspect to verify acceptance.
 - 3. Do not deliver materials to site more than two (2) weeks before use.
- B. Store materials in accordance with manufacturer's instructions.
 - 1. Store materials indoors in an area well ventilated and protected from damage.
- C. Do not store materials near open flame, sparks, or hot surfaces.
- D. Store materials on raised platforms and protected by waterproof covers.
- E. Keep material containers sealed until ready for use.
- F. Keep a copy of the applicable safety data sheets (SDS) with each material.
- G. Do not use materials beyond manufacturer's shelf life limits.

1.07 ENVIRONMENTAL REQUIREMENTS

A. Weather:

1. Air and Surface Temperatures: prepare surfaces and apply and cure coatings within air and surface temperature range in accordance with manufacturer's instructions.
2. Surface Temperature:
 - a. Minimum of 5°F above dew point and rising.
 - b. Do not apply to porous substrates when substrate or ambient temperatures are rising.
 - c. Do not apply to porous substrates when substrate is in direct sunlight.
 - d. Do not apply over substrates that are frozen or contain frost.
 - e. Provide lighting level of 80 foot candles measured mid-height at substrate surface.
 - f. Consult manufacturer for cold weather application instructions.
3. Relative Humidity: prepare surfaces and apply and cure coatings within relative humidity range in accordance with manufacturer's instructions.
4. Precipitation:
 - a. Do not prepare surfaces or apply coatings in rain, snow, fog, mist, or when moisture is imminent.
 - b. Do not apply when the surface may become wet within 4 hours after application.
5. Wind:
 - a. Do not spray coatings if wind velocity is above manufacturer's limit.
 - b. Protect all surrounding surfaces from overspray or wind carried coating materials.

B. Ventilation:

1. Provide ventilation during coating evaporation stage in confined or enclosed areas in accordance with AWWA D102 and these specifications.
2. Provide continuous ventilation and heating facilities to maintain surface and ambient temperatures above 45°F for 24 hours before, during, and 48 hours after application of finishes, unless required otherwise by manufacturer's instructions.

C. Dust and Contaminants:

1. Schedule coating work to avoid excessive dust and airborne contaminants.
2. Protect work areas from excessive dust and airborne contaminants during coating application and curing.

3. Refer to Paragraph 3.03 of this specification for additional requirements.

1.08 EXTRA STOCK

- A. Provide a one (1) gallon container of each color and type of paint to Owner. If coating is a two-part system, provide one (1) gallon containers of both parts for each color and type of paint.
- B. Label each container with color and application locations, in addition to the manufacturer's label.

1.09 REGULATORY REQUIREMENTS

- A. Conform to applicable codes and standards:
 1. North Dakota Department of Environmental Quality.
 2. Environmental Protection Agency
 3. Ten State Standards
 4. Uniform Building Code
 5. Uniform Fire Code
- B. All Products that may come into contact with water intended for use in a Public Water System shall meet ANSI/NSF International Standards 60 and 61, as appropriate. A Product will be considered as meeting these standards if so certified by NSF, the Underwriters Laboratories, or other organization accredited by ANSI to test and certify each Product.

1.10 WARRANTY

- A. Provide a five (5) year materials and two (2) year labor warranty. Obtain material warranty from manufacturer. Warranty period shall begin at the date of Substantial Completion as indicated in C700 General Conditions.

PART 2 PRODUCTS

2.01 APPROVED MANUFACTURERS

- A. All materials selected for coating systems for each type of surface shall be the Product of one (1) manufacturer.
 1. Euclid Chemical Co. – Tammscoat.
 2. Prior Approved Equivalent.

2.02 MATERIALS

- A. Coatings: ready mixed, except field-catalyzed coatings. Process pigments to soft paste consistency, capable of being readily and uniformly dispersed to a homogeneous coating.
- B. Coatings: good flow and brushing properties; capable of drying or curing free of streaks or sags.
- C. Accessory Materials: linseed oil, shellac, turpentine, paint thinners, and other materials not specifically indicated but required to achieve the finishes specified, of commercial quality.
- D. Materials shall contain no lead.

2.03 FINISHES

- A. Refer to schedule at end of Section for surface finish.
- B. Colors shall be selected by the Engineer.

2.04 APPLICATION EQUIPMENT

- A. For application of the approved paint, use only such equipment as is recommended for application of the particular paint by the manufacturer of the particular paint, and as approved by the Engineer.

PART 3 EXECUTION

3.01 EXAMINATION

- A. Verify that surfaces are ready to receive Work as instructed by the Product manufacturer.
- B. Examine surfaces scheduled to be finished prior to commencement of Work. Report any condition that may potentially affect proper application.
- C. Test shop applied primer for compatibility with subsequent cover materials.
- D. Beginning installation means acceptance of substrate condition.
- E. Measure moisture content of surfaces using an electronic moisture meter. Do not apply finishes unless moisture content of surfaces are below the following maximums:
 - 1. Masonry, Concrete, and Concrete Unit Masonry: 12 percent.

3.02 PREPARATION

- A. Prepare surfaces per manufacturer's recommendations.
- B. Correct minor defects and clean surfaces which affect Work of this Section.

- C. Seal marks which may bleed through surface finishes.
- D. Impervious Surfaces: Remove mildew by scrubbing with solution of tri-sodium phosphate and bleach. Rinse with clean water and allow surface to dry.
- E. Concrete and Concrete Masonry Unit Surfaces Scheduled to Receive Commercial Paint, Finish, or Liner:
 - 1. Provide clean, dry, and structurally sound concrete surfaces.
 - 2. Condition Survey: Perform a condition survey of existing concrete in accordance with ACI 201.1R.

3.03 PROTECTION

- A. Protect adjacent work and surrounding areas from contact with coating system.
- B. Protect elements surrounding the Work of this Section from damage or disfiguration. Repair damage to other surfaces caused by Work of this Section.
- C. Protect surfaces of coating systems from damage during construction.
- D. Replace identification markings on mechanical or electrical equipment when painted accidentally.
- E. Furnish and utilize drop cloths, shields, containment and ventilation to outside atmosphere, and other necessary protective methods to prevent blast media, fumes, overspray, or droppings from migrating or disfiguring other surfaces.

3.04 APPLICATION

- A. Apply products in accordance with manufacturer's instructions.
- B. Mix and thin coatings, including multi-component materials, in accordance with manufacturer's instructions.
- C. Keep material containers tightly closed until ready for use. Keep containers closed when not in use to avoid contamination.
- D. Do not use mixed coatings beyond pot life limits.
- E. Use application equipment, tools, pressure settings, and techniques in accordance with manufacturer's instructions.
- F. Keep equipment, air supplies, and application surfaces absolutely dry. Do not apply Products to surfaces that are not dry.
- G. Apply each coat to uniform finish and free of film characteristics or defects that would adversely affect performance or appearance of coating systems.
- H. Stripe paint with brush critical locations on steel such as welds, corners, and edges using specified primer.

- I. Apply each coat of paint slightly darker than preceding coat, unless otherwise approved.
- J. Sand lightly between coats to achieve required finish.
- K. Allow applied coat to dry before next coat is applied.
- L. Where clear finishes are required, tint fillers to match wood. Work fillers into the grain before set. Wipe excess from surface. Prime back surfaces of interior woodwork scheduled to receive stain or varnish with gloss varnish reduced 25 percent with mineral spirits.

3.05 REPAIR

- A. Damaged Materials: Repair or replace damaged materials and surfaces not scheduled to be coated and caused by Work of this Section.
- B. Damaged Coatings: Touch-up or repair damaged coatings. Touch-up of minor damage shall be acceptable where result is not visibly different from adjacent surfaces. Recoat entire surface where touch-up result is visibly different, either in sheen, texture, or color.
- C. Coating Defects: Repair in accordance with manufacturer's instructions coatings that exhibit film characteristics or defects that would adversely affect performance or appearance of coating systems.

3.06 FIELD QUALITY CONTROL

- A. Manufacturer's Field Services: Manufacturer's representative shall provide technical assistance and guidance for surface preparation and application of coating systems.
- B. Test coated areas as directed by Engineer.

3.07 CLEANING

- A. Remove and dispose of all temporary materials used to protect adjacent work and surrounding areas.
- B. Collect cotton waste, cloths, and material which may constitute a fire hazard, place in closed metal containers, and remove daily from Site. Do not deposit in Owner receptacles.
- C. During progress of Work, maintain premises free of unnecessary accumulation of tools, equipment, surplus materials, and debris.
- D. Immediately remove and clean Product materials from surfaces not intended to receive the materials.
- E. Replace electrical plates, hardware, light fixture trim, and fittings removed prior to finishing.

3.08 ONE-YEAR INSPECTION

- A. Engineer will set date for one-year inspection of coating systems.
- B. Inspection shall be attended by Owner, Contractor, Engineer, and manufacturer's representative.
- C. Repair deficiencies in coating systems as determined by Engineer in accordance with manufacturer's instructions.

3.09 PAINTING

- A. In general, all new and existing structures and items, including but not limited to the following surfaces, shall be painted, unless otherwise noted.
 - 1. Exterior concrete surface of reservoir.
- B. The following surfaces shall not be painted, unless otherwise indicated.
 - 1. Polished stainless steel, aluminum, galvanized finished metal and unpolished aluminum items.
 - 2. Prefinished items, unless noted otherwise.
 - 3. Stone veneer pilasters on exterior of reservoir.

3.10 PAINTING SCHEDULE

- A. General Painting Schedule
 - 1. Dome:
 - a. Receive one (1) coat of Tamoseal/Akkro-7T with an approximate thickness of 65 mils followed by one (1) coat of TAMMSCOAT Smooth with an approximate thickness of 15 mils, totaling a final coating thickness of 80 mils.
 - 2. Exterior Walls:
 - a. Receive two (2) coats of TAMMSCOAT Smooth with an approximate thickness of 15 mils, totaling a final coating thickness of 30 mils.
 - 3. Application Order:
 - a. Initial coat of TAMMSCOAT Smooth on exterior wall surface.
 - b. Initial coat of Tamoseal/Akkro-7th on exterior dome surface.
 - c. Final coat of TAMMSCOAT Smooth on exterior wall surface.
 - d. Final coat of TAMMSCOAT Smooth on exterior dome surface.

END OF SECTION

This page intentionally left blank

ATTACHMENT 01 EXISTING CONDITIONS

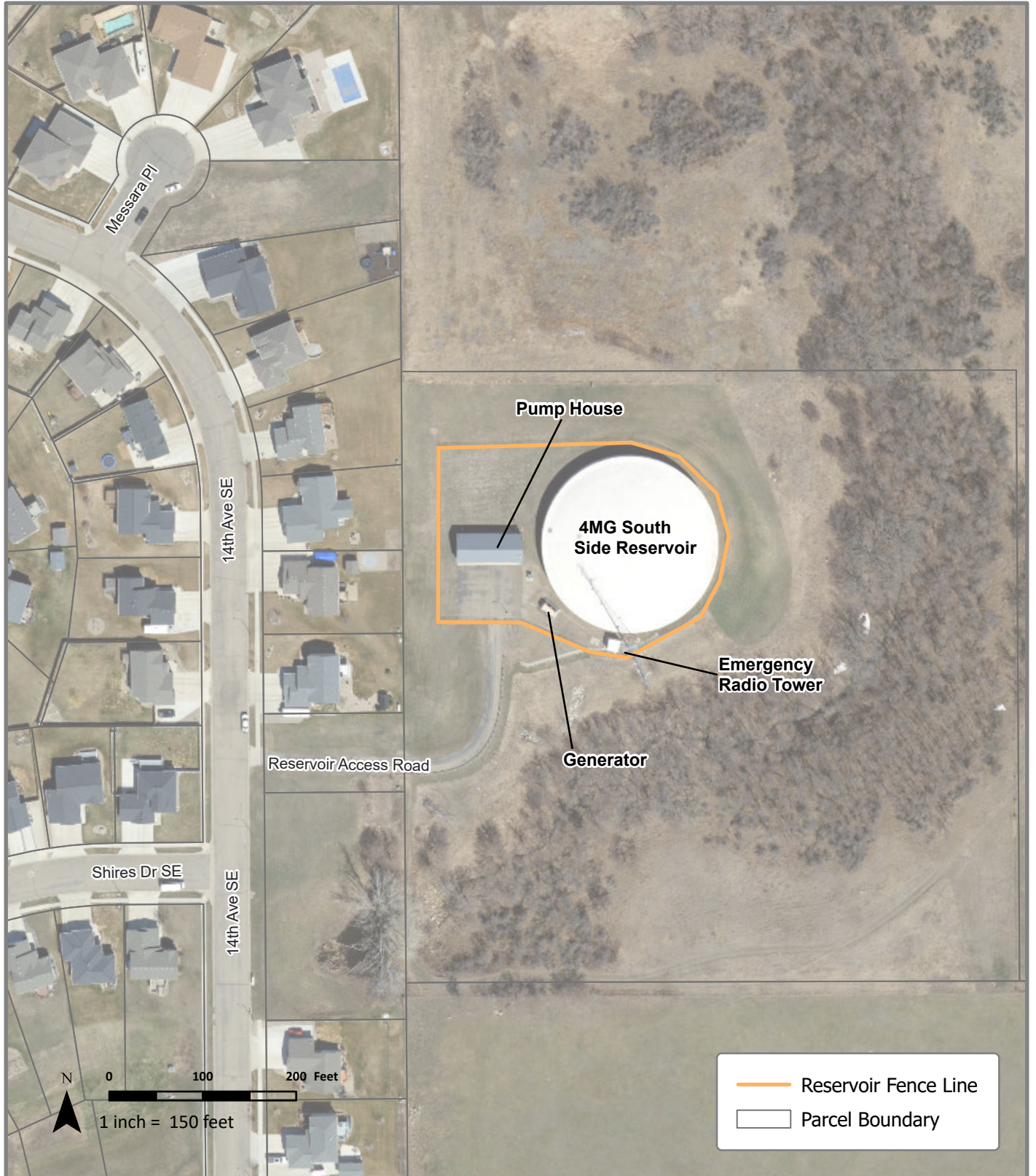

Information depicted may include data unverified by AE2S. Any reliance upon such data is at the user's own risk. AE2S does not warrant this map or its features are either spatially or temporally accurate.
Coordinate System: NAD 1983 StatePlane North Dakota South FIPS 3302 Feet Intl | Edited by: RVydrzal | C:\Data\Projects\Nasuni\M\Mandan\00510-2026-002\GIS\00510-2026-002 - Mandan South Side Reservoir Coating - Mapping and Analysis.aprx | P00510-2026-002 - Mandan South Side Reservoir Coating - Current Site Conditions



Locator Map Not to Scale

CURRENT SITE CONDITIONS

CITY OF MANDAN
Mandan | Morton County, ND



Date: 4/22/2026

Plotted By: Ian Smith, Date: Tuesday, January 03, 2017, Last Saved By: Ian Smith, Date: Friday, December 30, 2016 4:43:54 PM
 File: w:\Mandan\00510-2015-005-mandan south side pump station emergency generator\070-post construction_warranty\records drawings\06-electrical\E-Site Plan.dwg

CONSTRUCTION REQUIREMENTS FOR CONDUITS:	
1.	RMC WHERE EXPOSED (INTERIOR AND EXTERIOR).
2.	SCHEDULE 80 PVC UNDERGROUND.

CONSTRUCTION REQUIREMENTS FOR 600V POWER CONDUCTOR INSULATION:	
1.	TYPE THWN WHERE INSTALLED INDOORS WITHIN BUILDING CONFINES (TYPE P1).
2.	TYPE XHHW WHERE INSTALLED UNDERGROUND (TYPE P2).

SITE REFERENCE WITH GENERATOR. DIMENSIONS PROVIDED ARE FOR REFERENCE ONLY AND CONTRACTOR IS TO VERIFY ALL DIMENSIONS.

These record drawings show completed work in an approximate manner only. Notations of known field changes from the original design are based on information provided by the contractor(s) and designated with a Δ . Actual locations should be field verified. No warranty is implied or intended.

GENERAL NOTES

- SEE SHEET E1 FOR GENERAL NOTES.
- SEE SHEET E3 FOR SURFACE COVER INFORMATION.

CONSTRUCTION NOTES

- EXISTING UNDERGROUND BARE STRANDED COPPER GROUND GRID.
- EXISTING POLE MOUNTED ENTRANCE LIGHT.

APPROXIMATE 12-15 FEET BETWEEN FENCE AND RESERVOIR

APPROXIMATELY 7 - 9 FEET BETWEEN EXISTING 911 TOWER BUILDING AND RESERVOIR

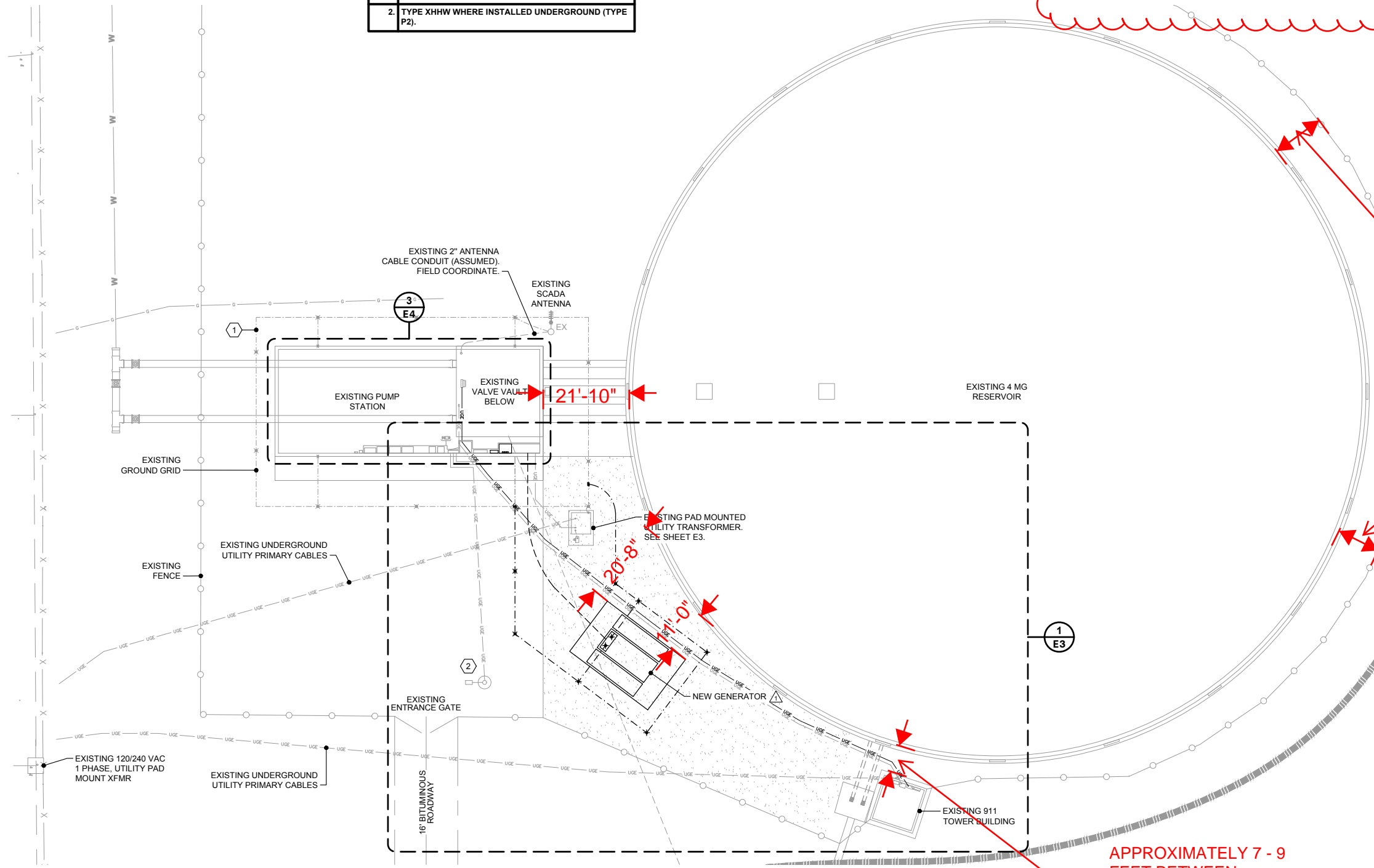

1 SOUTH SIDE PUMP STATION ELECTRICAL SITE PLAN
 15' 0 15' 30'
 NORTH

SYM	DATE	DESCRIPTION	DMC	APPR
Δ	01/03/17	RECORD DRAWING		



SOUTH SIDE PUMP STATION EMERGENCY GENERATOR
 CITY OF MANDAN
 MANDAN, NORTH DAKOTA
 ELECTRICAL SITE PLAN

2015-21
DRAWING TYPE CONSTR
PREPARED BY IPS
CHECKED / APPROVED KRP / DMC
DATE DEC 2015
PROJECT NUMBER P00510-2015-005
SHEET 4 of 12
DRAWING E2

File: W:\Mandant\00510-2015-005-mandan south side pump station emergency generator\05-electrical\05-site plan.dwg

Plotted By: Ian Smith Date: Tuesday, January 03, 2017 2:33:08 PM
Last Saved By: Ian Smith Date: Tuesday, January 03, 2017 2:33:08 PM

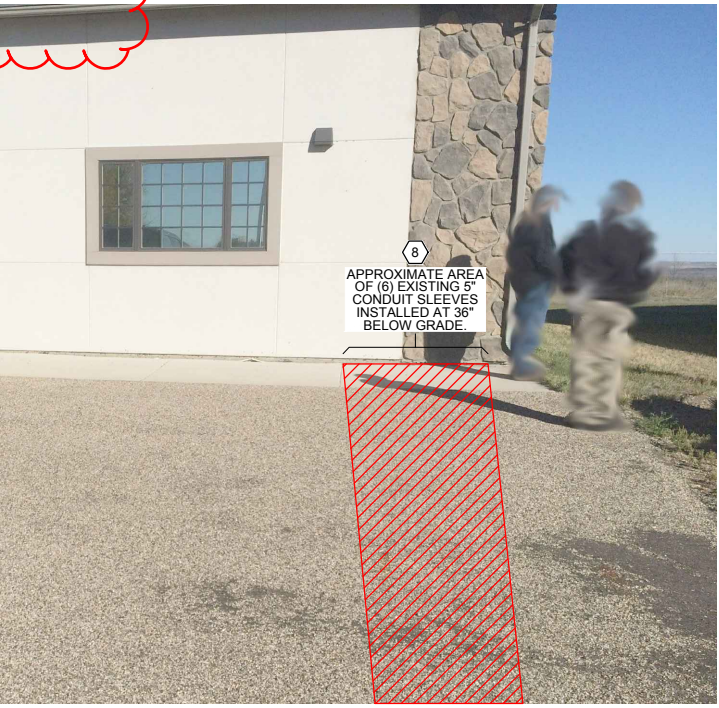
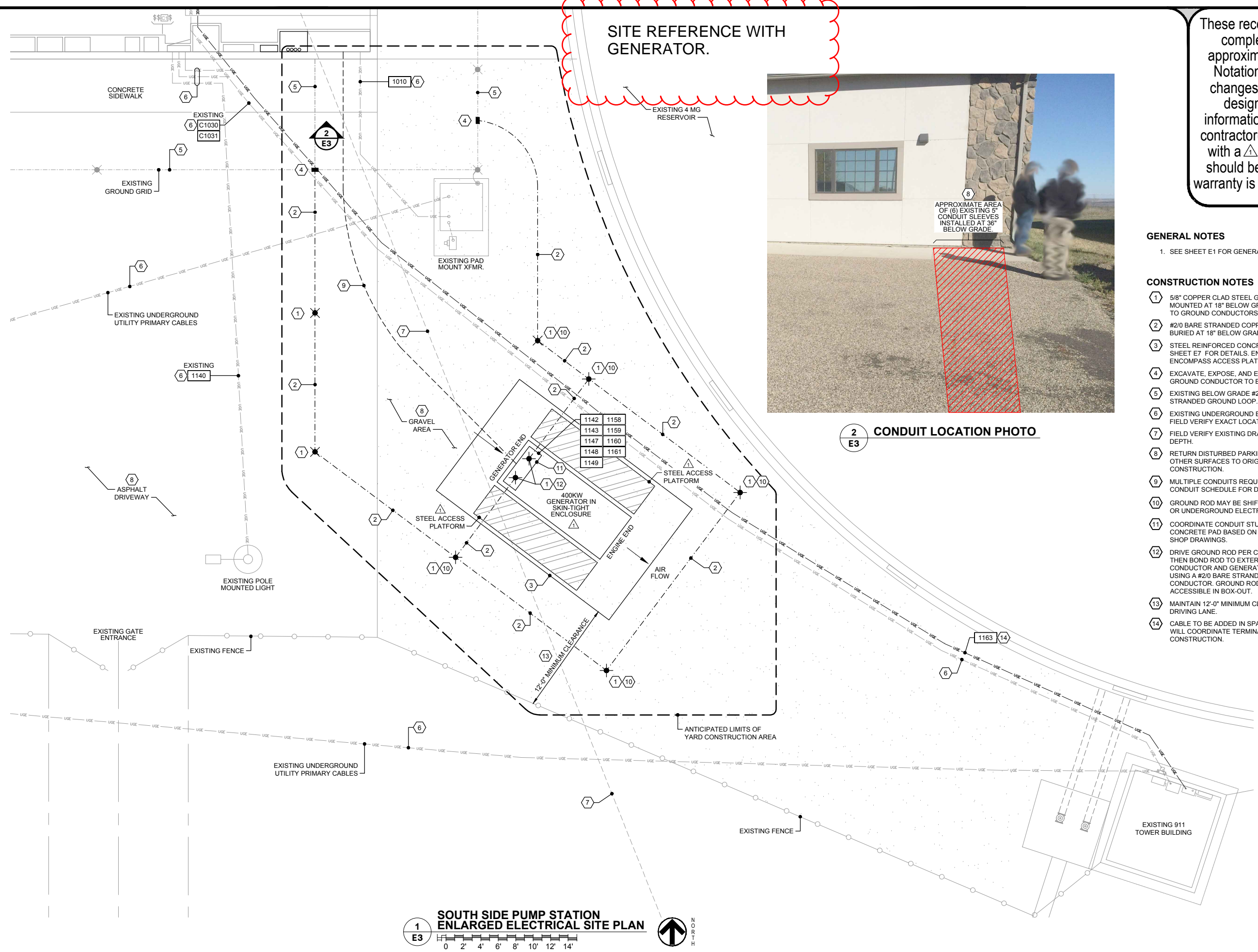

2 CONDUIT LOCATION PHOTO

These record drawings show completed work in an approximate manner only. Notations of known field changes from the original design are based on information provided by the contractor(s) and designated with a Δ . Actual locations should be field verified. No warranty is implied or intended.

GENERAL NOTES

- SEE SHEET E1 FOR GENERAL NOTES.

CONSTRUCTION NOTES

- 5/8" COPPER CLAD STEEL GROUND ROD WITH TOP MOUNTED AT 18" BELOW GRADE. EXOTHERMIC WELD TO GROUND CONDUCTORS.
- #2/0 BARE STRANDED COPPER GROUND CONDUCTOR BURIED AT 18" BELOW GRADE.
- STEEL REINFORCED CONCRETE GENERATOR PAD. SEE SHEET E7 FOR DETAILS. ENLARGE PAD TO ENCOMPASS ACCESS PLATFORM.
- EXCAVATE, EXPOSE, AND EXOTHERMIC WELD NEW GROUND CONDUCTOR TO EXISTING GROUND GRID.
- EXISTING BELOW GRADE #2/0 BARE COPPER, STRANDED GROUND LOOP.
- EXISTING UNDERGROUND ELECTRIC CONDUCTORS, FIELD VERIFY EXACT LOCATION.
- FIELD VERIFY EXISTING DRAIN PIPE LOCATION AND DEPTH.
- RETURN DISTURBED PARKING LOT, SIDEWALK AND OTHER SURFACES TO ORIGINAL STATE AFTER CONSTRUCTION.
- MULTIPLE CONDUITS REQUIRED. SEE CABLE AND CONDUIT SCHEDULE FOR DETAILS.
- GROUND ROD MAY BE SHIFTED TO AVOID THE DRAIN, OR UNDERGROUND ELECTRIC (UGE).
- COORDINATE CONDUIT STUB-UP BOX-OUT THROUGH CONCRETE PAD BASED ON FUTURE MANUFACTURER SHOP DRAWINGS.
- DRIVE GROUND ROD PER CONSTRUCTION NOTE 1 AND THEN BOND ROD TO EXTERNAL GROUND GRID CONDUCTOR AND GENERATOR EQUIPMENT FRAME USING A #2/0 BARE STRANDED COPPER GROUND CONDUCTOR. GROUND ROD TOP SHOULD BE LEFT ACCESSIBLE IN BOX-OUT.
- MAINTAIN 12'-0" MINIMUM CLEARANCE TO MAINTAIN DRIVING LANE.
- CABLE TO BE ADDED IN SPARE CONDUIT. ENGINEER WILL COORDINATE TERMINATION POINTS DURING CONSTRUCTION.

1 SOUTH SIDE PUMP STATION ENLARGED ELECTRICAL SITE PLAN

E3

SYM	DATE	DESCRIPTION	DMC	APPR



SOUTH SIDE PUMP STATION EMERGENCY GENERATOR
 CITY OF MANDAN
 MANDAN, NORTH DAKOTA
 PARTIAL ENLARGED ELECTRICAL SITE PLAN

2015-21
DRAWING TYPE CONSTR
PREPARED BY IPS
CHECKED / APPROVED KRP / DMC
DATE DEC 2015
PROJECT NUMBER P00510-2015-005
SHEET 5 of 12
DRAWING E3

REVISED TO SHOW RECORD DRAWINGS - 01/2017

DIAMETER OF RESERVOIR AT EXTERIOR WALLS TO RECEIVED COATINGS.

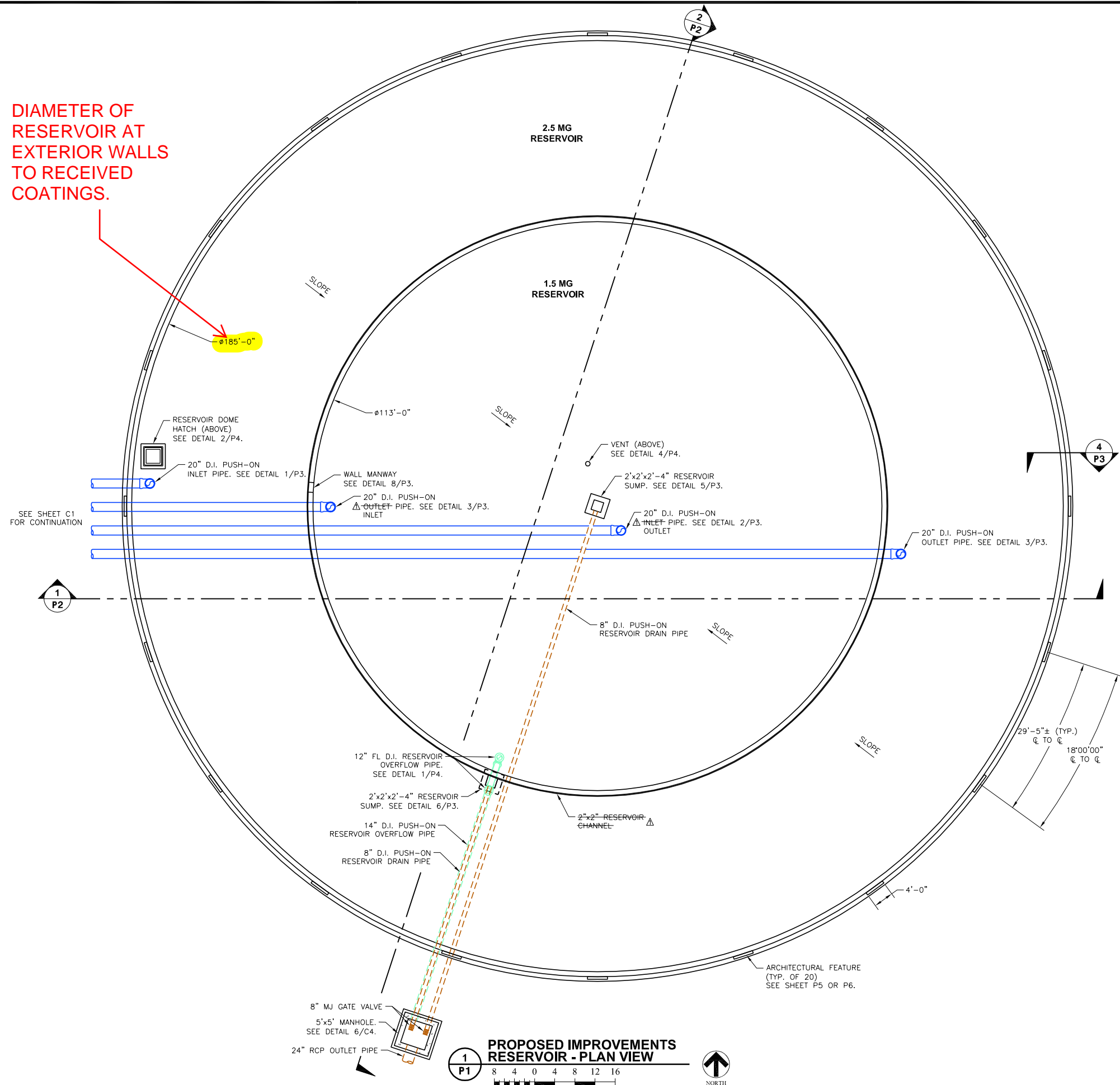

D.I. PIPE CLASS

LESS THAN OR EQUAL TO 12" - CLASS 350
 GREATER THAN 12" - CLASS 250

GENERAL NOTES

1. CONTRACTOR IS RESPONSIBLE FOR FIELD VERIFICATION OF ALL DIMENSIONS.
2. CONTRACTOR IS RESPONSIBLE FOR PROTECTION OF EQUIPMENT.
3. VERIFY FINAL VALVE ACTUATOR/OPERATOR ORIENTATION WITH ENGINEER.
4. NOT ALL PIPE HANGERS AND SUPPORTS ARE SHOWN. PROVIDE PIPE HANGERS AND SUPPORTS PER SPECIFICATIONS AND DETAIL DRAWINGS.
5. CONTRACTOR IS RESPONSIBLE FOR PROVIDING ANCHORS, RESTRAINTS, AND SUPPORT ON ALL PIPING AS REQUIRED OR DIRECTED BY ENGINEER.
6. PREPARE, PRIME, AND PAINT ALL MANHOLE PIPING, FITTINGS, VALVES, ETC IN ACCORDANCE WITH SPECIFICATION 09900.
7. SEE SITE PLAN SHEET FOR SELECT QUANTITIES.

DATE	REVISION	APPROVED
12-15-10	RECORD DRAWING	RRS



MANDAN SOUTH SIDE 4 MG RESERVOIR
 MANDAN SOUTH SIDE
 MANDAN, NORTH DAKOTA
 PROPOSED RESERVOIR - PLAN VIEW

DRAWING TYPE	CONSTR.
DRAFTER	TRK
CHECKED / APPROVED	LDH/RRS
DATE	July 2008
PROJECT NUMBER	P00510-2008-00
SHEET	13 of 34

P1

REVISED TO SHOW RECORD DRAWINGS - 12/15/2010

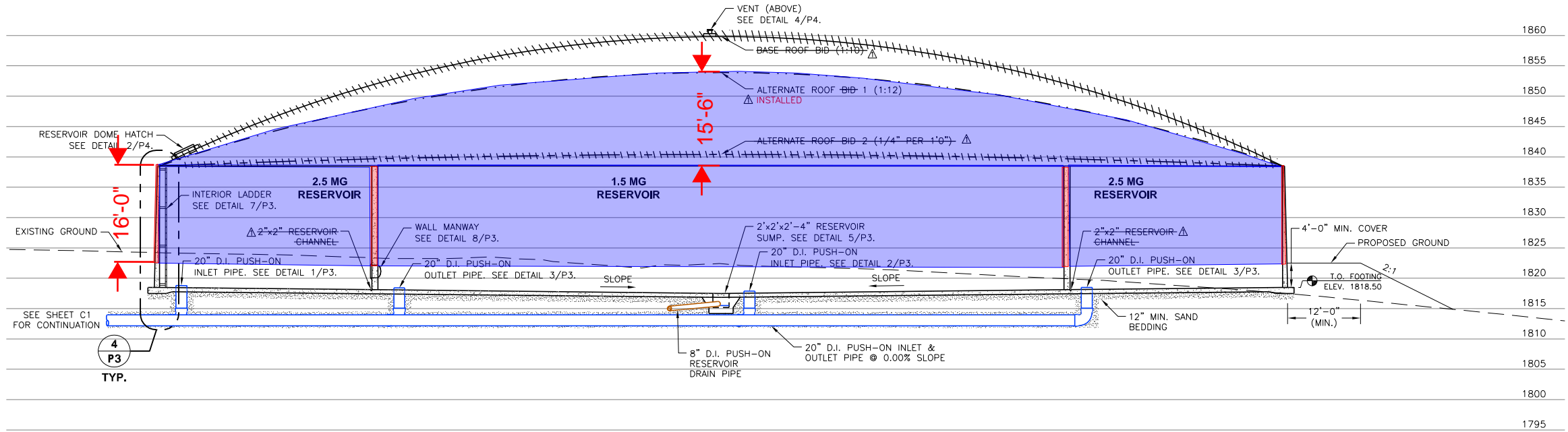

1
 P2
**PROPOSED IMPROVEMENTS
 RESERVOIR - CROSS SECTION**
 8 4 0 4 8 12 16

GENERAL NOTES

1. CONTRACTOR IS RESPONSIBLE FOR FIELD VERIFICATION OF ALL DIMENSIONS.
2. CONTRACTOR IS RESPONSIBLE FOR PROTECTION OF EQUIPMENT.
3. VERIFY FINAL VALVE ACTUATOR/OPERATOR ORIENTATION WITH ENGINEER.
4. NOT ALL PIPE HANGERS AND SUPPORTS ARE SHOWN. PROVIDE PIPE HANGERS AND SUPPORTS PER SPECIFICATIONS AND DETAIL DRAWINGS.
5. CONTRACTOR IS RESPONSIBLE FOR PROVIDING ANCHORS, RESTRAINTS, AND SUPPORT ON ALL PIPING AS REQUIRED OR DIRECTED BY ENGINEER.
6. PREPARE, PRIME, AND PAINT ALL MANHOLE PIPING, FITTING, VALVES, ETC IN ACCORDANCE WITH SPECIFICATION 09900.
7. SEE SITE PLAN SHEET FOR SELECT QUANTITIES.

■ SURFACES NOT COATED
 ■ SURFACES TO BE COATED
 NOTE DIMENSIONS PROVIDED ARE FOR REFERENCE PURPOSES ONLY. CONTRACTOR TO VERIFY EXACT DIMENSIONS.

DATE	REVISION	RECORD DRAWING
12-15-10	1	RECORD DRAWING



MANDAN SOUTH SIDE 4 MG RESERVOIR
 MANDAN SOUTH SIDE
 MANDAN, NORTH DAKOTA
 PROPOSED RESERVOIR - CROSS SECTIONS

DRAWING TYPE	CONSTR.
DRAFTER	TRK
CHECKED / APPROVED	LDH/RRS
DATE	July 2008
PROJECT NUMBER	P00510-2008-00
SHEET	14 of 34

P2

REVISED TO SHOW RECORD DRAWINGS - 12/15/2010

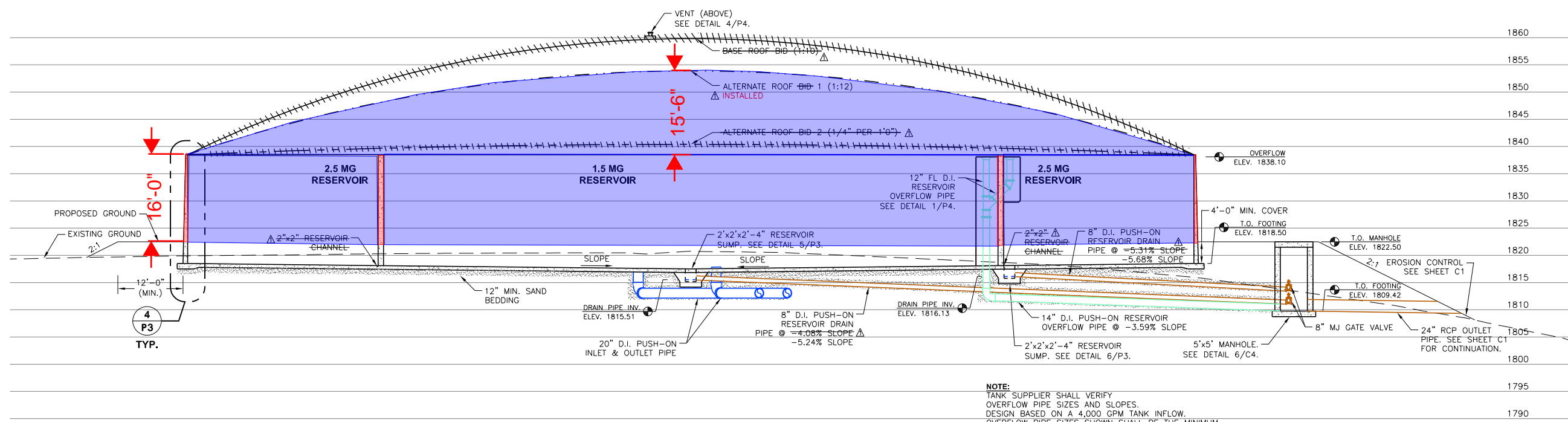

2
 P2
**PROPOSED IMPROVEMENTS
 RESERVOIR - CROSS SECTION**
 8 4 0 4 8 12 16

NOTE:
 TANK SUPPLIER SHALL VERIFY OVERFLOW PIPE SIZES AND SLOPES. DESIGN BASED ON A 4,000 GPM TANK INFLOW. OVERFLOW PIPE SIZES SHOWN SHALL BE THE MINIMUM.

D.I. PIPE CLASS
 LESS THAN OR EQUAL TO 12" - CLASS 350
 GREATER THAN 12" - CLASS 250

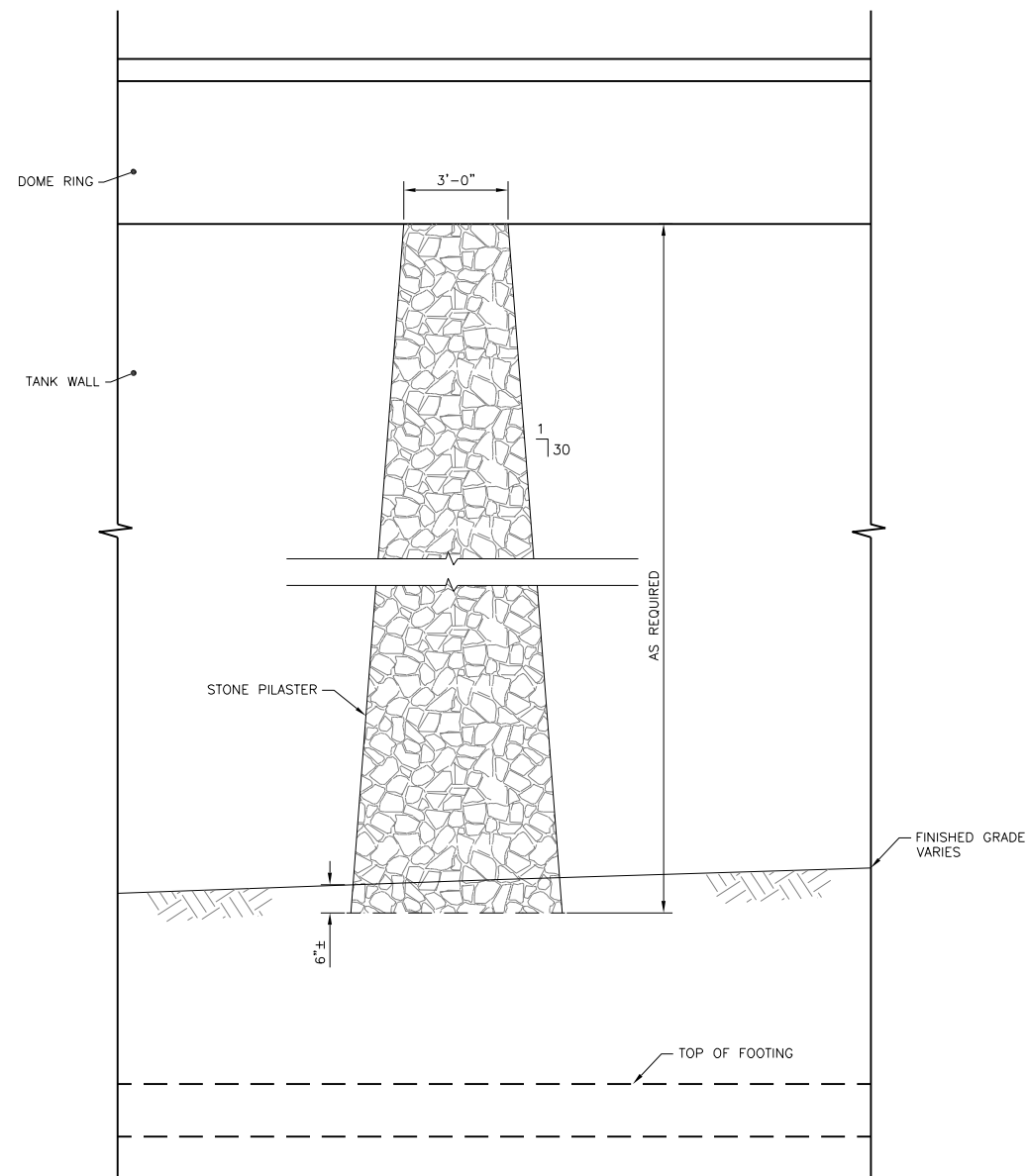

1
P6
RESERVOIR ELEVATION AT STONE VENEER PILASTER (ALTERNATE BID)
 SCALE: NONE

REFERENCE FOR STONE VENEER PILASTER DIMENSIONS NOT RECEIVING COATINGS.

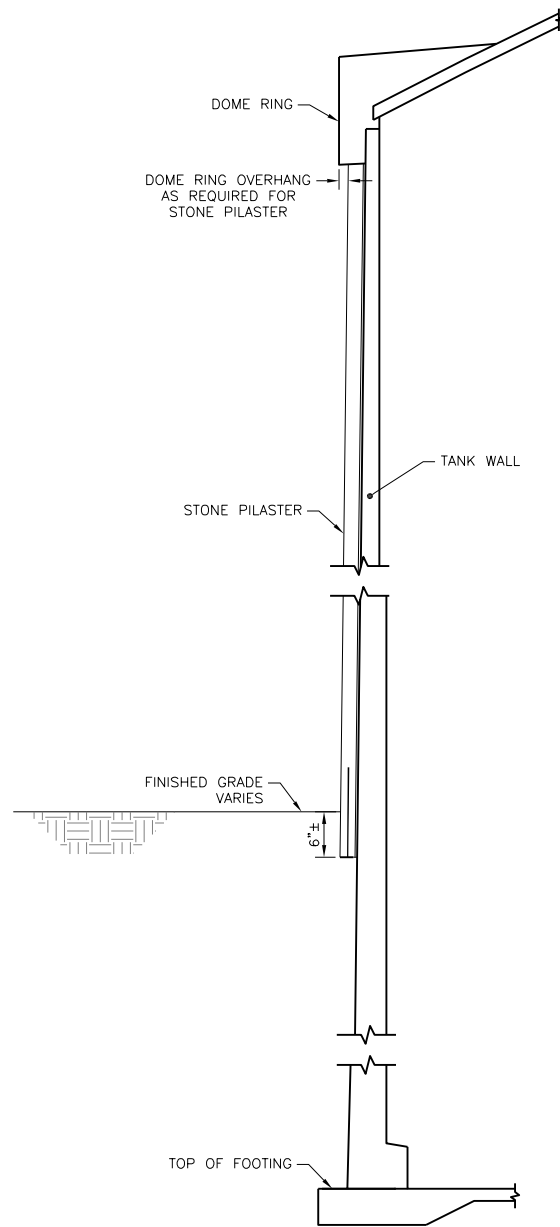

2
P6
RESERVOIR SECTION AT STONE VENEER PILASTER (ALTERNATE BID)
 SCALE: NONE

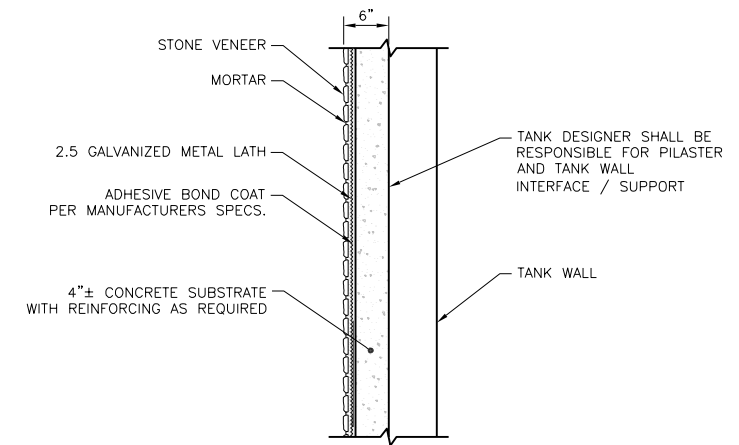

3
P6
STONE PILASTER CONCRETE SUBSTRATE WITH STONE VENEER DETAIL
 SCALE: NONE

NOTES:

1. BASE BID TO INCLUDE SHOTCRETE/STUCCO FINISH ON WALLS AND DECORATIVE COATINGS AS SPECIFIED.
2. BASE BID TO INCLUDE 20 CONCRETE PILASTERS SPACED EVENLY AROUND PERIMETER OF TANK TO SUPPORT LOAD.
3. TANK DESIGNER SHALL BE RESPONSIBLE FOR PILASTER DESIGN & PROPER SUPPORT.
4. ALTERNATE BID STONE VENEER PATTERN AS SPECIFIED PER SECTION 13220.
5. OWNER RESERVES THE RIGHT TO CHANGE THE STONE PATTERN WITHIN THE SUPPLIERS COST STRUCTURE AT NO ADDITIONAL COST. CHANGES RESULTING IN AN INCREASE IN SUPPLIER MATERIAL COSTS SHALL BE BORN BY THE OWNER. CHANGES RESULTING IN A DECREASE IN SUPPLIER MATERIAL COST SHALL BE DEDUCTED FROM THE PROJECT BID AMOUNT.

DATE	REVISION	APPROVED
12-15-10	RECORD DRAWING	RRS



MANDAN SOUTH SIDE 4 MG RESERVOIR
MANDAN SOUTH SIDE
MANDAN, NORTH DAKOTA
 PROPOSED RESERVOIR - ARCHITECTURAL FEATURES (ALTERNATE BID)

DRAWING TYPE	CONSTR.
DRAFTER	TRK
CHECKED / APPROVED	LDH/RRS
DATE	July 2008
PROJECT NUMBER	P00510-2008-00
SHEET	18 of 34

P6